

Adding to
your sewing
enjoyment

SEWING MACHINE

ACCESSORIES CATALOG

JANOME

Adding to your sewing enjoyment

Janome accessories help make your sewing more comfortable and enjoyable.

Each of our accessories has been developed to be easy to use and give beautiful results so that you can sew with confidence knowing it is a Janome.

The first step in cultivating your sewing skills is choosing the right tools.

Let this catalog guide you for the projects you may have in mind and serve as inspiration for your new ideas.

Janome Sewing Machine Compatibility Quick Reference Guide

Use this quick reference guide to determine compatibility of an accessory with your Janome sewing machine.



A
7 mm Sewing or Embroidery
Combo (High Shank)



B
Embroidery Only



C
7 mm Sewing with AcuFeed
(High Shank)



D
7 mm Sewing Models
(Low Shank)



E
6.5 mm Sewing (Low Shank,
Top-loading, Horizontal rotary
hook - Mechanical)



F
5 mm Sewing (Low Shank,
Top Loading - Mechanical)



G
Front loading (Low Shank,
Oscillating hook - Mechanical)



H
Sergers



I
Cover-Stitch



J
Straight Stitch / High Speed
(High Shank)



K
Needle Punching



L
Multi-Needle Embroidery



M
Combination Sergers
and Cover-Stitch



N
9 mm Sewing and Embroidery
with AcuFeed (High Shank)



O
9 mm Sewing and Embroidery
(High Shank)



P
9 mm Sewing with AcuFeed
(High Shank)



Q
9 mm Sewing
(High Shank)

Maximum Zigzag Width

key info. 1

The maximum zigzag width of stitches is from 5 mm to 9 mm depending on the sewing machine.

High Shank and Low Shank of Presser Foot Holder

key info. 2

High shank means that the presser foot holder is installed at a higher position.

Most sewing machines with embroidery features and/or the AcuFeed system are equipped with the high shank type of presser foot holder.

Low shank means that the presser foot holder is installed at a lower position.

AcuFeed System

key info. 3

AcuFeed Flex is a feature only available on premium Janome sewing models.

The system uses Upper Feed Teeth in conjunction with Lower Feed Teeth to gently move multiple layers of fabric through the machine. The Upper Feed Teeth move with the fabric as the Lower feed teeth move, feeding both the top and bottom layers of fabric at the same time.

There are three variations of Acufeed Flex feet available in the Janome range: Twin, Single and Professional.

GROUP	DESCRIPTION	CANADIAN MODELS
A	7 mm Sewing or Embroidery Combo (High Shank)	Skyline S3 Memory Craft (11000, 10000, 10001, 9700)
B	Embroidery Only	Memory Craft (550E, 500E, 400E, 350E, 230E)
C	7 mm Sewing with AcuFeed (High Shank)	Memory Craft (7700QCP, 6600P, 6500P)
D	7 mm Sewing Models (Low Shank)	Memory Craft (5200, 4900) QDC (2160, 2030, 3160, 4030, 4120, 4300, 5060, 5300) DC (2019, 7060, 7100, 6030) 6260QC, 6100 Maker Series (M50, M100, M150, M200) Sewist (780DC, 740DC) C30 Schoolmate 7330 MyStyle100
E	6.5 mm Sewing (Low Shank, Top-loading, Horizontal rotary hook - Mechanical)	Décor (5124, 5024, 5018) MyExcel (4014, 4018, 4023, 4123) HD (718, 3000, 5000) C30 6019QC, 6125QC MyExcel 18/23
F	5 mm Sewing (Low Shank, Top Loading - Mechanical)	Sewist (521, 525, 625E, 709, 721, 725S) Sew Mini Jem (Gold , Gold 2, Platinum 760) Magnolia 7318 712T
G	Front loading (Low Shank, Oscillating hook - Mechanical)	234, 2212, 2112, 3012, 3016, 3022, 419S, 423S, 415, 405 311 (Arctic Crystal, Blue Couture, Pink Sorbet) 1522 (RD, DG, DB, PG) L (392, 372, 393, 373) HD 1000 SUV (1108, 1122)
H	Sergers	PG (793, 792) FA4 FourDLB / DLM XG-43D 9102D AT2000D Magnolia 7034D
I	Cover-Stitch	900CP, 1000CP, 1000CPX, 2000CPX CP 3000 PROFESSIONAL

GROUP	DESCRIPTION	CANADIAN MODELS
J	Straight Stitch / High Speed (High Shank)	1600P HD-9
K	Needle Punching	FM725
L	Multi-Needle Embroidery	MB-4, MB-4S, MB-7
M	Combination Sergers and Cover-stitch	1200D 1100D
N	9 mm Sewing and Embroidery with AcuFeed (High Shank)	Memory Craft (15000, 14000, 12000) Skyline S9 Continental M17
O	9 mm Sewing and Embroidery (High Shank)	Memory Craft (9900, 9850)
P	9 mm Sewing with AcuFeed (High Shank)	Skyline (S7, S6) Memory Craft (9450QCP, 9400QCP, 8900QCP, 8200QCP, 6700P) Continental M7
Q	9 mm Sewing (High Shank)	Skyline S5 MC6650

Table of contents

■ JANOME QUALITY	8
■ CATALOG OF ACCESSORIES	13
■ FOR GENERAL SEWING MACHINES	14
■ FOR OVERLOCKERS	35
■ FOR COVER STITCH MACHINES	39
■ FOR PROFESSIONAL OVERLOCKERS AND COVER STITCH MACHINES	43
■ FOR HIGH SPEED MACHINES	47
■ NEEDLE PUNCHING	54
■ MISC. ACCESSORIES	56

Package information

Package specifications are listed.

BP: Blister pack



CB: Cardboard box



NP: No packaging or shipped in a plastic bag



Janome Engineering and Craftsmanship for Better Quality Sewing

Exclusive features of Janome presser feet and accessories give you more control and accuracy for a higher quality finish. Calculated for effectiveness and full of originality, you can be assured that the history and tradition of quality Janome engineering is behind not only every sewing machine, but every presser foot and accessory as well.



Grooves guide fabric and thread

Special grooves on the underside of feet promote optimal fabric feed for best results. On the left, the diagonal grooves on the underside of the blind hem foot improve contact of the fabric with the center guide plate for more accurate blind hems. On the right, outlets are provided on the underside of the zigzag foot to help grab the thread as it exits and improve stitch quality.

Button locks foot tilt

Who hasn't been frustrated by stitching bunching up before a thick seam? Although sewists normally appreciate the free tilt of a sewing foot, sometimes this feature can work against you when the foot comes up against a thick seam. To help you have perfect stitching over even the thickest seams, Janome provides a button on the zigzag foot that locks it horizontally parallel to the thread plate for smooth sewing over seams or other areas of significantly varying thicknesses. This feature can also be used at the beginning of sewing thick fabrics for a perfect start.

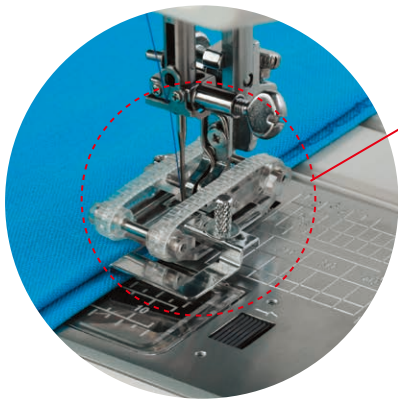

Caterpillars for better control

Most presser feet are flat. But what do you do when there is a significant difference in the height of the fabric on the left of the needle from that on the right, such as when finishing hems and edges of thick material? This is where the unique design of the Janome rotary even foot comes into play. The foot allows left-right tilt and its caterpillars independently grip the fabric for exceptional control, even over thick seams.

Multiple functions in one presser foot set

From idea to reality. When our customers say, "Wouldn't it be handy if...", we listen to their ideas. The feet that come with the convertible FMQ set are interchangeable and the guide on the 1/4 inch clear-view quilting foot can be removed. This means the feet can be matched precisely to the purpose with 1 set providing a range of functions. That's why these items fulfill user needs and are proving to be popular.

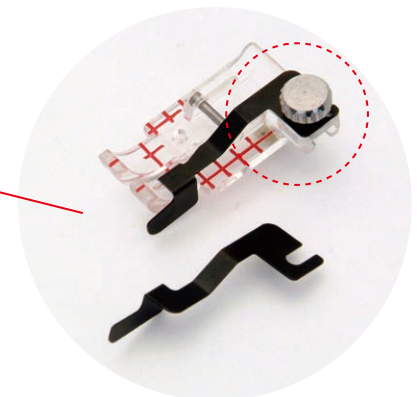



ACUFEED: Layered Fabric Feeding System

Janome truly integrates a built-in walking foot with a unique seven point feed dog system. Since the top layer is fed in perfect timing with the bottom layer, all fabrics move smoothly, even the slippery ones like velvet or thick layers of quilting fabric and batting, and heavy home dec yardage. Perfect feeding also means perfect alignment of patterns such as checks and plaids.

ACUFEED FLEX™

In addition to the original twin type, single type feet can now be used, expanding sewing possibilities. AcuFeed Flex™ keeps your thickest, trickiest layers moving in perfect sync with the feed dogs. You're going to love the new AcuFeed Flex™ feet for stitching your fluffiest quilts, installing zippers, or matching seams!

The AcuFeed Flex™ fabric feeding system is fully detachable and easy to remove when you're not using it. Select the presser foot that best matches your sewing needs and attach. Simply snap off when not in use and store out-of-the-way in one of the ample accessory trays. Multiple twin type and single type feet are available to address different tasks.





AcuFeed (twin type):

The twin type AcuFeed attachments give you superior stability by taking full advantage of a wider stance. Engage the exclusive AcuFeed fabric feeding system and feel your project moving together under the needle with perfect precision.

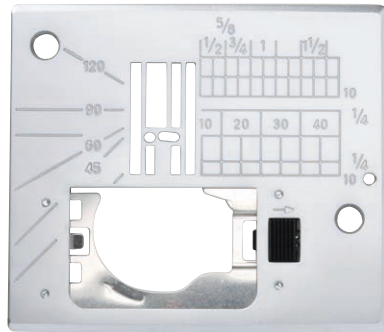

ACUFEED 1/4 INCH SEAM FOOT AND NEEDLE PLATE

Guides edge of fabric to help you sew perfect 1/4 inch seams, especially useful for patchworking. The small needle hole on the needle plate prevents fabric from being pushed under the needle plate.

846-407-007	C	BP
-------------	---	----

* Needle plate only compatible with MC6600P

ACUFEED 1/4 INCH SEAM FOOT

202-031-002	C	BP
-------------	---	----

ACUFEED QUILT PIECING FOOT (Dual feed quilt piecing foot)

202-125-004		N P BP
-------------	--	--------



ACUFEED OPEN TOE FOOT (Dual feed open toe foot)

Front of foot has been removed for clearer visibility when sewing. Great for applique, monogramming, cutwork and quilting.

846-410-003	C	BP
202-149-004		N P BP

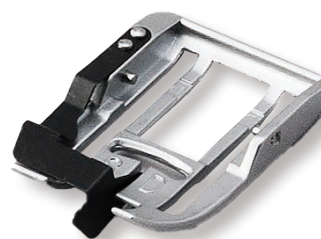

ACUFEED DITCH QUILTING FOOT (Dual feed ditch quilting foot)

Center-position guide follows a seam line precisely, allowing perfect in-the-ditch quilting. Used in conjunction with various needle positions, it is also perfect for topstitching or under-stitching a facing.

846-413-006	C	BP
202-103-006		N P BP



ACUFEED STRAIGHT STITCH FOOT

The circle hole in the foot holds the thread in place and allows for a quality straight stitch. Using together with straight stitch needle plate is recommended.

202-102-005		N P BP
-------------	--	--------

*The product named "AcuFeed" in this catalog is identical to the product named "Dual feed" in the sewing machine instruction manual.



AcuFeed (single type):

The single type dual feed attachments let you get in close to sew a narrower area as well as the edges of cloth.

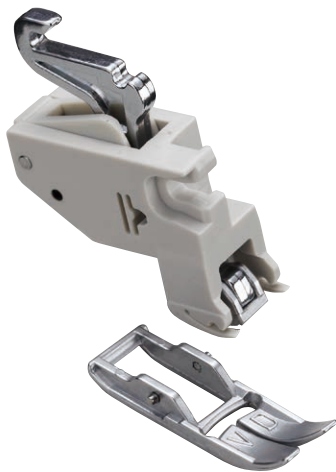

**ACUFEED FOOT WITH FOOT HOLDER
(Dual feed foot with Dual feed holder)**

This foot has the power to feed fabrics. It is especially effective for top-stitching on the edge of the fabric and stitching on narrow strips.

202-127-006	N	P	BP
-------------	---	---	----

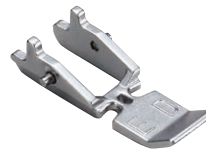

**ACUFEED ZIPPER FOOT
(Dual feed zipper foot)**

Zippers can be attached to plastic coated fabric, leather and any tricky to handle materials without any difficulty.

202-128-007	N	P	BP
-------------	---	---	----

*The product named "AcuFeed" in this catalog is identical to the product named "Dual feed" in the sewing machine instruction manual.



ACUFEED FLEX PROFESSIONAL GRADE FOOT

This foot provides superior visibility and is great for curves and precise topstitching. It holds fabrics firmly in sync with the feed dogs to achieve professional results.

* To use this accessory, you will need the HP needle plate that comes with your sewing machine.

202-415-004	N*1 P*2	BP
-------------	---------	----

*1 For use with MC15000, Skyline S9, CM17 only
*2 For use with MC9400, MC9450, CM7P only





CATALOG OF ACCESSORIES

Using the correct presser foot and accessory for the job at hand not only makes it easier to complete, but also lets you achieve more beautiful finished results. Further it means that you will have less strain on your eyes for a more enjoyable sewing experience. Let this catalog guide you to the right accessories to meet your sewing needs.

Use the handy quick reference guide to determine the compatibility of each accessory with your Janome sewing machine.



GENERAL SEWING MACHINE ACCESSORIES

General sewing machines are versatile and user friendly. Let Janome presser feet and accessories expand your sewing repertoire.

STRAIGHT STITCH FOOT

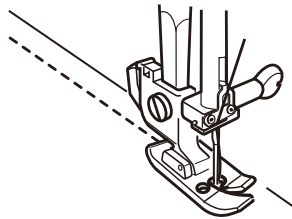

The straight stitch foot is flat on the underside to provide even pressure against the feed dogs and it has a rounded needle hole which offers the benefit of more support around the needle to prevent skipped stitches and puckering.

200-331-009	A CDEF	BP
200-125-008	G	BP
202-083-009		NOPQ BP

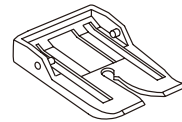

ACUFEED STRAIGHT STITCH FOOT

202-102-005		N P BP
-------------	--	--------

APPLIQUE FOOT

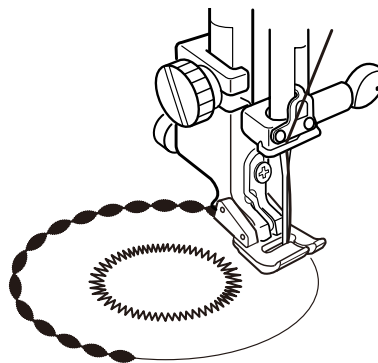

This presser foot is shorter than most for easier maneuvering around curves and corners when sewing applique pieces. Made of clear plastic for easier viewing as you sew.

202-023-001	A CDEF	BP
202-086-002		NOPQ BP

SLIDING GUIDE FOOT

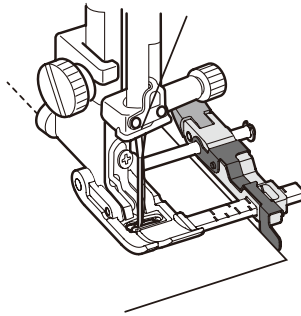
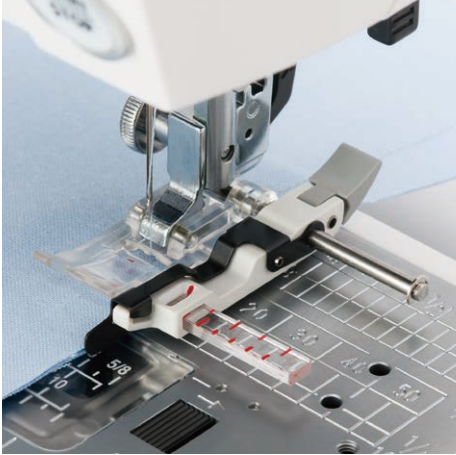

This foot is ideal for seaming with a 5/8 inch allowance, and the adjustable seam guide allows precise edge stitching and hemming.

202-293-004		NOPQ	BP
202-218-005	A CDEF		BP

ROLLER FOOT

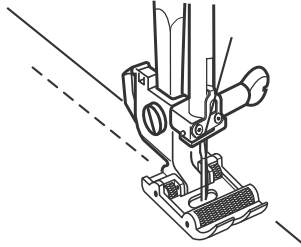

As its name suggests this foot has rollers that roll against the fabric and act very much like the track on a bulldozer for sewing up and over heavy seams and uneven surfaces. Ideal for sewing heavy fabrics, the rollers move freely between the foot and the feed dogs so that the foot rides easily over varying thicknesses. Also used to sew sticky leathers and vinyl.

200-316-008	A CDEF		BP
200-142-001	G		BP

DARNING FOOT

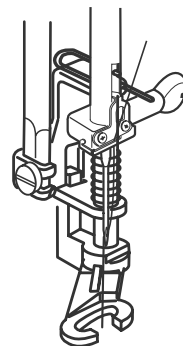

Sometimes referred to as the embroidery foot, the darning foot is used for 'free hand' embroidery and darning to ensure proper stitch formation, minimize skipped stitches and puckering and also protect your fingers while you move the fabric freely under the needle. Especially beneficial to those just learning how to do free hand embroidery. The open toe version greatly improves visibility of stitches and is especially popular with quilters.

(REGULAR)

200-325-000	A C		BP
200-349-000	DEF		BP
200-127-000	G		BP
859-839-002		NOPQ	NP

(OPEN TOE)

200-337-005	A C		BP
200-340-001	DEF		BP

ULTRA GLIDE NEEDLE PLATE & ULTRA GLIDE FOOT

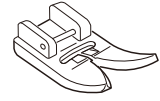
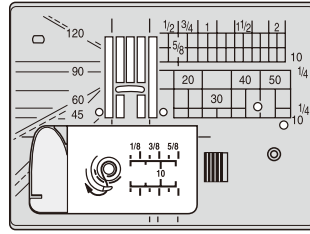

Molded from a special resin that allows easier sewing of sticky materials, the ultra glide foot moves smoothly over faux leather, ultra suede, vinyl and even plastics on the ultra glide needle plate. This non-stick attachment glides along with no drag so you can sew on these surfaces just like they were regular fabric.

(ULTRA GLIDE FOOT)

200-329-004	A CDEF	BP
200-141-000	G	BP
202-091-000	NOPQ	BP

(ULTRA GLIDE NEEDLE PLATE & ULTRA GLIDE FOOT)

202-201-005	N*3OP*1Q	BP
202-431-006	N*4 P*2	BP

*1 excl. CM7P *3 excl. CM17

*2 For use with CM7P only *4 For use with CM17 only

HD ROLLER FOOT



An innovative new foot that can smoothly control materials such as leather and vinyl which are prone to catch. When using this foot, the base of the needle is clearly visible, making your work easier.

202-418-007	A C	J	NOPQ	BP
-------------	-----	---	------	----



SATIN STITCH FOOT

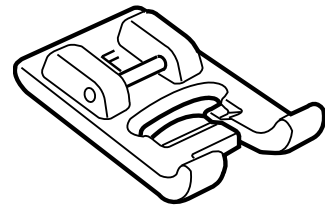

For sewing dense zigzag stitching. The bottom of the foot is beveled for smooth delivery of thread when sewing decorative or satin stitches. Foot is made of clear plastic making it easier to view stitching.

822-804-129	A CDEF	NP
200-129-002	G*1	BP
859-806-011		NOPQ NP

*1 Foot is made of metal.

GATHERING FOOT

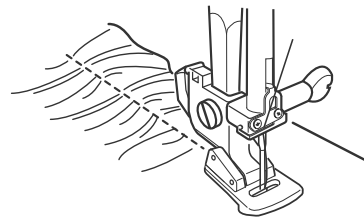

This foot is for creating soft gathers in lightweight fabrics. The underside of the foot is raised behind the needle and has a thick bar in front of the needle to gather and attach a ruffle onto a flat piece of fabric simultaneously. Use a ruffler to obtain a more dramatic gather.

200-315-007	A CDEF	BP
200-124-007	G	BP
202-096-005		NOPQ BP

CUSTOM CRAFTED ZIGZAG FOOT

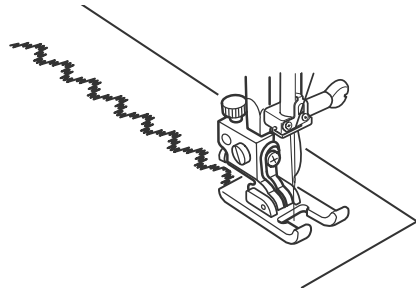
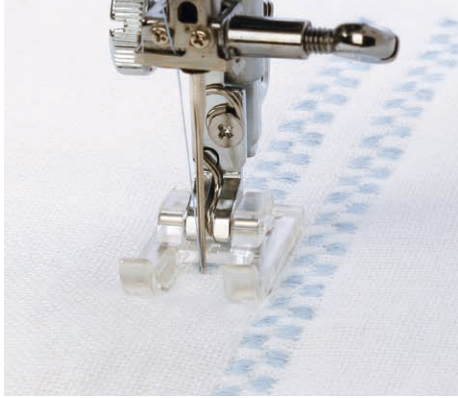

The open toe on this foot allows a better view of the sewing in progress. This foot can be used for quilting, monogramming, applique, and cut work.

200-137-003	A CDEF	BP
859-813-000	NOPQ	NP

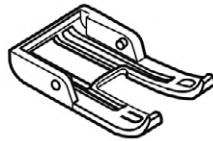

ACUFEEED OPEN TOE FOOT

846-410-003	C	BP
202-149-004	N P	BP

BINDER FOOT

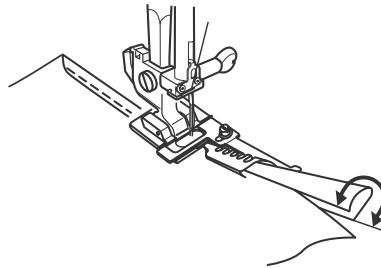

The binder foot is used to apply pre-folded bias binding tape or bias tape you have cut yourself to the edge of fabric in one easy step. It is equipped with a small funnel to fold and guide the binding over the fabric edge before it reaches the needle and can be used with either zigzag or decorative stitches as well as straight stitch. 10 mm to 14 mm bias tape can be used.

200-313-005	A CDEF	BP
200-140-009	G	BP
202-099-008	NOPQ	BP



BI-LEVEL FOOT

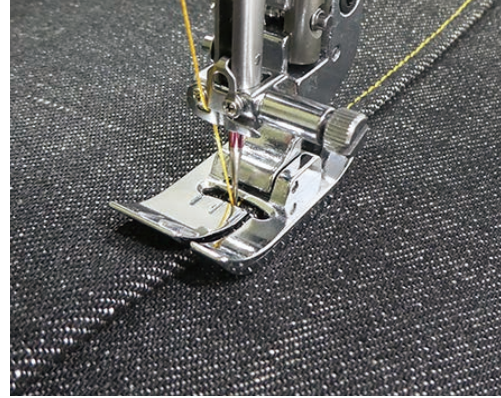

This foot enables sewing at a constant width from the fold of the fabric. It guides your top stitching and edge stitching perfectly. Thick materials (e.g. wool, denim, tweed) can be finished.

202-461-005		NOPQ	BP
-------------	--	------	----

TAPING GUIDE FOOT



Use this foot for attaching tape to the edge of fabrics. Adjust the needle drop position with the thumb screw. Guide the fabric with the left hand and tape with the right hand.

202-310-008		NOPQ	BP
202-311-009	A CDEF		BP

LAP-SEAM FOOT



This foot can provide perfect looking and durable seams on medium-heavy weight to heavy weight fabrics. You can create beautiful lap-seams without ironing.

202-463-007		NOPQ	BP
-------------	--	------	----



OVERCASTING FEET

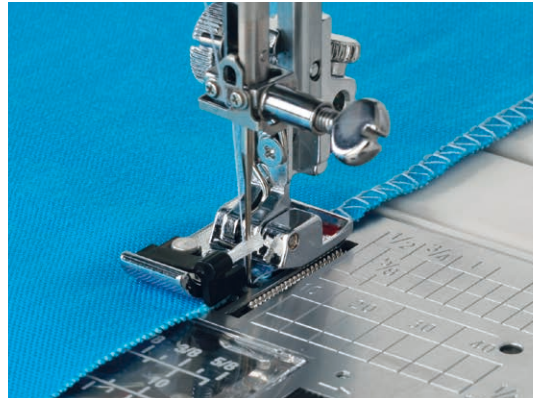

OVEREDGE FOOT

Use with an overcasting stitch to allow thread to wrap around the edge of the fabric to prevent unraveling. The foot guides the fabric and keeps your edges flat by compensating for the lack of friction when the needle makes the right-most stitch.

822-801-001	A CDEF	NP
200-132-008	G	BP

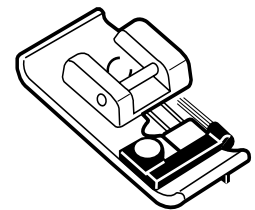

OVERCASTING FOOT / OVEREDGE FOOT

Use with the overlock stitch to give a professional finish to the edges of your seams. Particularly good for finishing off medium to heavyweight, easily frayed woven fabrics such as tweed, gabardine, and linen.

822-808-008	A CD*1	NP
859-810-007	NOPQ	NP

*1 excl. MC3500, MC3000, 6260QC

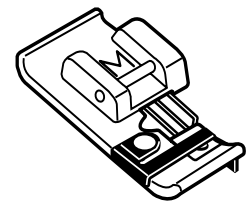

BLIND HEM FOOT

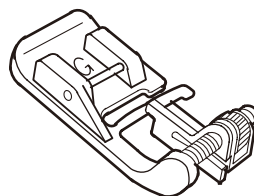
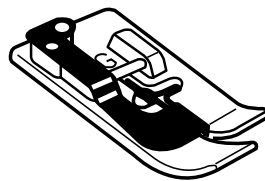

Blind hemming can sometimes be a little bit tricky so the blind hem foot goes some way to helping improve this technique. The foot has a metal guide in the center and three grooves on the underside. During blind hemming, the fold of the fabric fits snugly against the guide in the foot for accuracy while the grooves underneath help to prevent unnecessary slipping. The needle swings over the metal guide creating slack in the upper tension so that the pick of the stitch is almost invisible.

825-817-009	A CDEF	NP
820-817-015	A CDEF*1	NP
200-130-006	G	BP
859-807-001	NOPQ	NP

*1 Foot is equipped with a screw.



ZIPPER FOOT

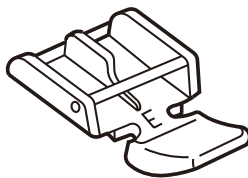

This foot can be set to sew on each side of the zipper. The edge of the foot guides the zipper to ensure straight placement.

(SNAP ON)

808-852-003	A CDEF	NP
940-290-000	G	NP

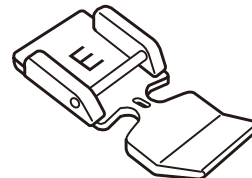

Set the needle position left or right to sew on each side of the zipper.

(SNAP ON)

859-805-009	NOPQ	NP
-------------	------	----

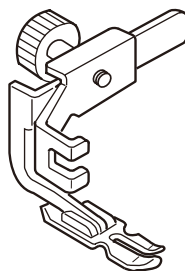

Can also be used as piping foot for thicker piping including the heavy jumbo cord.

(SCREW ON)

200-334-002	A C	BP
200-342-003	DEFG	BP

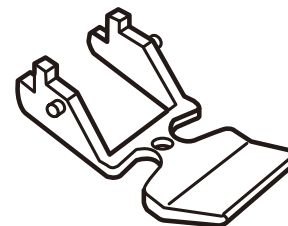

ACUFEEED ZIPPER FOOT

202-128-007	N P	BP
-------------	-----	----

CONCEAL[®] ZIPPER FOOT

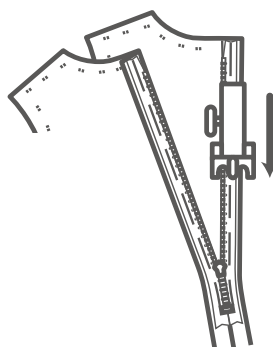

Good quality ready to wear garments will often have an invisible zip fitted. These zippers are often neglected by the home dressmaker which is a pity because they can ensure success every time. Invisible zips are suitable for all fabrics from fine silk jersey through to suit weight wools and tweeds. The key is to get the needle as close to the fastener as possible, which this foot accomplishes by slightly unrolling the zipper just before the needle. Once fitted, a well sewn invisible zipper will merely look like part of the seam.

(SNAP ON)

200-333-001	A CDEF	BP
202-475-002	G	BP
202-144-009	NOPQ	BP

(SCREW ON)

941-800-000	G	NP
-------------	---	----

CONCEAL is a registered trademark of YKK Corporation.

HEMMER FEET



The hemmer foot, sometimes referred to as the rolled hemmer, is used to stitch the narrow rolled hems usually found on shirt tails, table linens and along the edge of frills. The hemmer is designed with a scroll shaped feeder on top and a straight groove on the underside which determines the width of the finished hem. The 4 mm/6 mm set will allow for the use of heavier fabrics.

HEMMER FEET SET (4 mm & 6 mm hems)

200-326-001	A CDEF	BP
-------------	--------	----

HEMMER FOOT(4 mm)

202-081-007		NOPQ BP
-------------	--	---------

HEMMER FOOT(6 mm)

202-080-006		NOPQ BP
-------------	--	---------

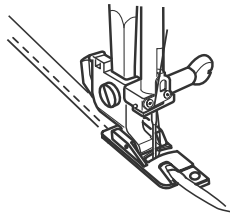

ROLLED HEM FOOT

820-809-014	A CDEF	NP
202-044-008	G	BP
859-804-008		NOPQ NP

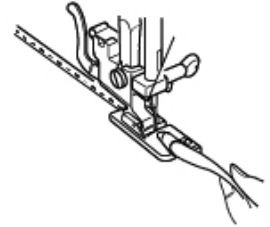

ROUND HEMMER FOOT

202-477-004	G	BP
-------------	---	----

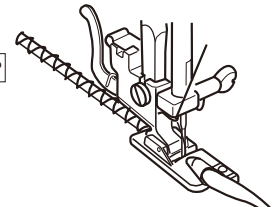

ROTARY EVEN FOOT

323-77-77	A CDEF	CB
-----------	--------	----

For use with all sewing machines, the rotary foot is effective for preventing stretchy fabrics, jersey and knitted fabrics and hard to feed materials like leather or vinyl, from slipping or puckering. The foot also allows left-right tilt and its caterpillars independently grip the fabric for perfect feeding along areas where there is a height difference between the left and right sides of the needle especially when hemming thicker fabrics.

*When using zigzag stitch, set the stitch width at a setting less than 5mm.
CAUTION: In order to avoid needle breakage, do not set stitch width at more than 5mm.



BLIND HEM ATTACHMENT



The blind hem attachment enables accurate feeding of the fabric to achieve a consistent blind hem.

BIAS TAPE ATTACHMENT

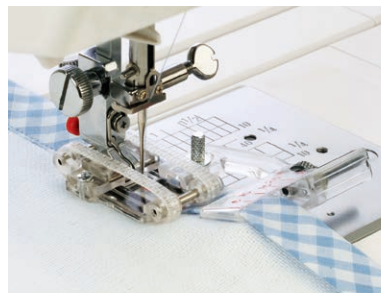

The bias tape sewing attachment is adjustable and enables you to attach folded bias tape up to 20 mm wide.

WIDE ROLLED HEM ATTACHMENTS



The wide rolled hem attachments enable wide rolled hems to be sewn in the following sizes: 1/2 inch, 3/4 inch, and 1 inch.

PIPING FOOT

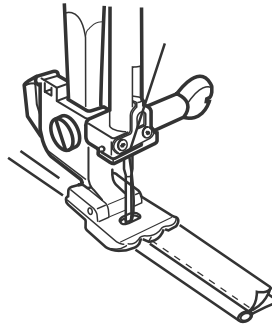

If ready made piping cord is not available or if you just want to make your own, the piping foot is ideal for the job. The piping foot (sometimes mistakenly referred to as the cording foot) is designed with two grooves on the underside and will hold and cover the cord when making piping tape. It can also be used for attaching piping. Maximum cord size is 5 mm.

200-314-006	A CDEF	BP
202-088-004		NOPQ BP

PIPING FOOT (NARROW)

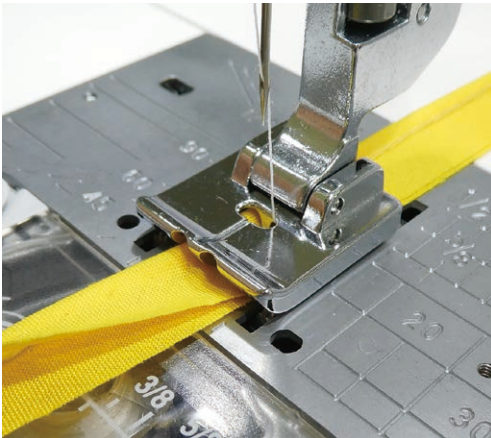

This foot is used for piping with a cord diameter of about 2 mm. It is useful for making narrow piping tape using the same fabric as the piece of work, or for attaching piping tape to fabric.

202-462-006		NOPQ BP
-------------	--	---------



PINTUCKING FEET

The pintucking foot is used with a 2 mm twin needle to create multiple rows of pintucks. The grooves on the underside of the foot make it easy to stitch several rows parallel and evenly spaced from each other.

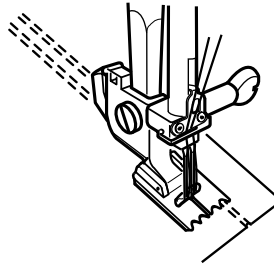

SET OF TWO FEET

(narrow grooved and wide grooved)

200-317-009	A CDEF	BP
-------------	--------	----

SINGLE FOOT (shallow grooved only)

200-328-003	G	BP
-------------	---	----

PINTUCKING FOOT (narrow)

202-094-003	NOPQ	BP
-------------	------	----

PINTUCKING (wide)

202-093-002	NOPQ	BP
-------------	------	----

PINTUCKING CORD GUIDES

The cord guide is attached in place of the clear plastic bobbin cover to feed perle cotton or other cord as you sew for easier corded pintucks. Two guides are included in the set: one for cord up to 1.5 mm in diameter and one for cord 1.5 - 2.5 mm in diameter.

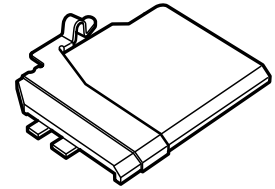

Part Number	Package	Remarks	Compatible Model						
			Harmony 4045/4052	6019QC 6125QC	FD216/212/206 Sew Mini Platinum	M30A	3160QDC 2160DC 2030DC	4120QDC 5120QDC 4300QDC	TS100Q TS200Q
503-813-008	CB	Easy Set Bobbin System is not supported	502	503	508	805	808A/D/F/S/X	809A/AS	811A
			6260QC	MC6600P MC6500P	MC8900QCP MC8200QCP	MC12000	MC11000		
			845	846A/F	858F/G	859A	860		
200-324-009	BP	Easy Set Bobbin System is not supported	MS5027 MS5021 CS5031 SC5021	Sewinst 625E 525S/521 725S/721	Easy Jeans 22 MyStyle 22	Jem Gold	Jem Gold2	MyExcel 4014/4018 4023/4123	HD2200 MyExcel 18/23
			505	507	654	660	661	751	753
			Décor 5124 5024 5018	Jem Platinum	DC4030	MC8000	MC9000	MC5700 MC5000	MC3500 MC3000
			757	806	807	830	832	834	840
			MC4800	DC4100	DC3018 DC3030 DC3060 DC8350	MC5200	MC4900	MC10000 MC10001	MC9500
			841	842	843	844	847	850	853
			MC9700						
857									
202-213-000	BP	Metal Needle Plate with Easy Set Bobbin System is required	5300QDC 5270QDC	M50QDC M100QDC M200QDC	Sewist 780DC 740DC	MC8900QCP SE	MC9900 MC9850	MC15000 MC14000 Skyline S9	Skyline S3/S5/S6/S7
			809AU/AU2	812	814	858F2	861	862A2/A3/S	863
			MC9450QCP MC9400QCP	MC6700P MC6650	CM7P	CM17			
			865	866	867	868			

RUFFLER

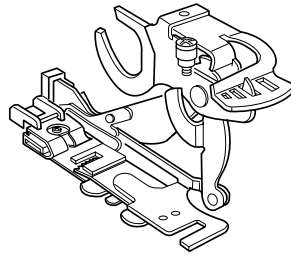

Rufflers have been around for a very long time and have changed very little over the years; they have however remained very popular. Although at first sight a ruffler may appear bulky and complicated, its innovative design actually makes it very easy to use. This design allows fabric to be ruffled or pleated to the desired fullness quickly and easily and also has the capability to vary the sizes of ruffles.

943-100-000	A DEFG	CB
846-415-008	A CDEFG	BP
202-095-004		NOPQ BP

BEADING FOOT

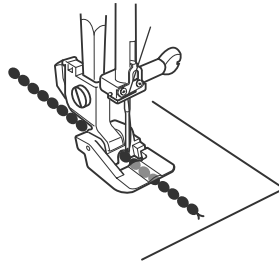

Sewing on strung beads and pearls has always been a tedious task but the beading foot now goes some small way to alleviating this and to add pleasure to embellishing. Popular for bridal wear, evening wear, smart/casual or crafts, the beading foot set is a blessing. There are two feet in the set: narrow groove for beads up to 2 mm in diameter and wide groove for beads 2.5 - 4 mm in diameter.

SET OF TWO FEET (narrow and wide)

200-321-006	A CDEF	BP
-------------	--------	----

BEADING FOOT (narrow)

202-097-006		NOPQ BP
-------------	--	---------

BEADING FOOT (wide)

202-098-007		NOPQ BP
-------------	--	---------

3-WAY CORDING FOOT

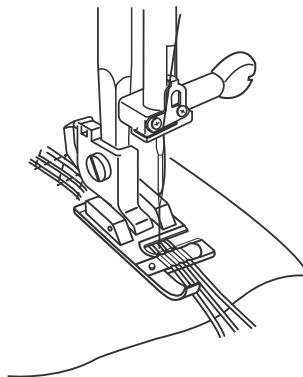

The 3-way cording foot will hold one, two or three fine cords or threads. Because they are attached to the foot, the required design can be easily followed and the cords are perfectly placed. A variety of utility or decorative stitches can be sewn over the cords to couch them onto base fabrics. The choice of cord, thread and stitch are all contributory factors to the final effect.

200-345-006	A CDEF	BP
200-126-009	G	BP
202-085-001		NOPQ BP

RIBBON/SEQUIN FOOT

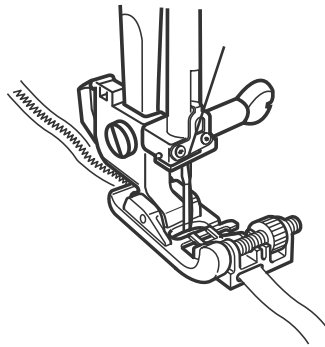

As with beads and pearls it is now so much easier to attach ribbons and even sequins with the help of our special ribbon/sequin foot. This foot is designed with guides through which ribbon or strung sequins can be inserted and it will allow them to feed through evenly as you sew. Besides affixing the ribbon, a wide ladder stitch can be used with narrow ribbon to make an easy and functional drawstring.

200-332-000	A CDEF	BP
202-090-009		NOPQ BP

BUTTONHOLE FEET

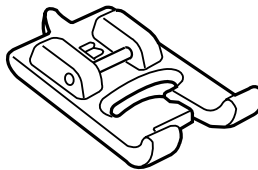
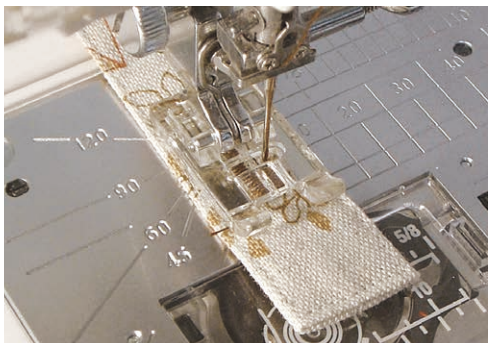

TRANSPARENT BUTTONHOLE FOOT

For sewing buttonholes on tight areas such as cuffs and other areas where more freedom of movement is required than available with a sliding-type buttonhole foot.

820-801-016	A CDEF	NP
202-082-008		NOPQ BP

SLIDING BUTTONHOLE FOOT

For easy 4-step buttonholes on front loading machines. (Sliding buttonhole foot included as standard accessory on all sewing machines with a 1-step buttonhole function.)

(REGULAR)

200-123-006	G	BP
-------------	---	----

(WITH BUTTON SIZER)

200-134-000	G	BP
-------------	---	----

BUTTON SEWING FOOT

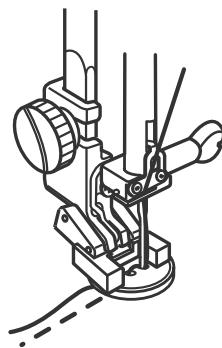

Quick and easy button sewing with the special button sewing foot. This foot has two bars that attach to the foot shank to provide extra stability and also has a textured, rubber sleeve to hold the button securely in place while sewing.

200-136-002	A CDEF	BP
200-131-007	G	BP
859-811-008		NOPQ NP

1/4 INCH SEAM FOOT



A popular foot with patchworkers for that essential 1/4 inch seam. The guide on the foot enables you to sew a perfect 1/4 inch seam every time. The guide can also be used wherever a 1/4 inch seam is called for but the markings on the needle plate cannot be used, such as when completing a flat-felled seam.

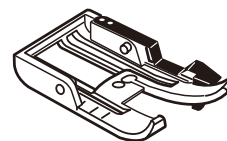
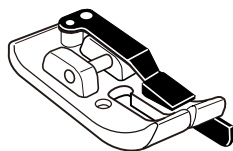

ACUFEED 1/4 INCH SEAM FOOT AND NEEDLE PLATE

846-407-007	C	BP
-------------	---	----

* The needle plate only compatible with MC6600P

200-318-000	A CDEF	BP
200-330-008	G	BP
859-814-012	NOPQ	NP

ACUFEED QUILT PIECING FOOT

202-031-002	C	BP
202-125-004	N P	BP

1/4 INCH SEAM FOOT (WITHOUT GUIDE)

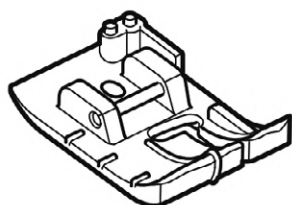

As with the 1/4 inch seam foot, this foot enables you to sew the 1/4 inch position by aligning the cloth with the edge of the presser foot. Fabric can be fed stably using the wide area of the foot.

202-313-001	NOPQ	BP
-------------	------	----

CLEAR VIEW 1/4 INCH SEAM FOOT



This foot allows you to sew 1/4 inch seam piecing, indispensable for quilt work, using the straight stitch needle plate.

The small single hole in both the plate and the foot ensures the most control over fabric possible and the least risk of threads or fabric getting caught in the feed dogs.

*Must be used with a straight stitch in center needle drop position.

202-216-003	NOPQ	BP
-------------	------	----

DITCH QUILTING FOOT



A very useful addition to the sewing room when wanting a perfectly straight "stitch in the ditch". The guide on the foot spreads the seams allowing you to stitch perfectly in the ditch, and is also useful when adding decorative top stitching along seams.

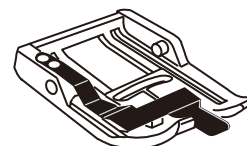
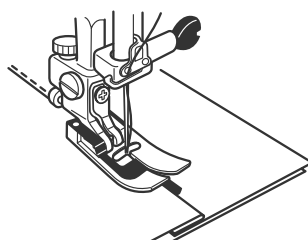

ACUFEED DITCH QUILTING FOOT

200-341-002	A CDEF	BP
202-087-003	NOPQ	BP

846-413-006	C	BP
202-103-006	N P	BP

CLEAR VIEW QUILTING FOOT AND GUIDE SET

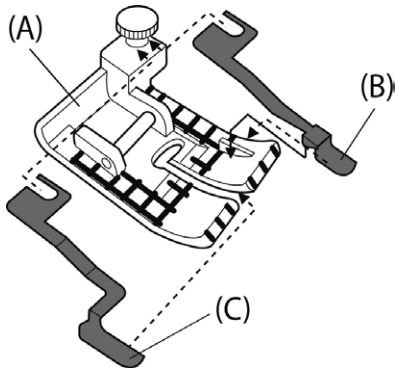

(A) Clear view quilting foot
 (B) 1/4 inch seam guide
 (C) Ditch quilting guide

An essential set for all quilters because it covers a range of quilting tasks through the attachment or removal of two fabric guides and the use of a clear view foot. Create accurate 1/4 inch seams with the 1/4 inch guide, or remove the guide to make a 1/8 inch seam for miniature piecing using the handy markings on the clear foot. To decorate your quilt, attach the center guide to ensure a neat "stitch in the ditch" for the perfect finishing touch.

200-449-001	A CDE	BP
202-089-005		NO PQ BP



Simply attach the 1/4 inch fabric guide which aligns with the edge of the material to produce an accurate 1/4 inch seam with ease. The oval hole in the clear view foot allows for needle adjustment of up to 1 mm to create a scant 1/4 inch seam.



Add dimension to your quilt using the "stitch in the ditch" technique. The center guide attached to the foot spreads the seams to create perfect stitching in the ditch. Don't stop with straight ditch stitching - experiment with decorative stitches for eye-catching embellishment.



Some quilting techniques may require you to sew with some fabric under the fabric guide, so use the clear view foot without a guide to help the fabric move easily under the foot. The markings on the foot act as a guide for 1/4 inch and 1/8 inch seams.

EVEN FEED FOOT



The even feed foot, sometimes referred to as the walking foot, is designed with a set of feed dogs (teeth) which allow the fabric to feed without shifting and eliminates the problems of the underlayer of fabric coming up short. The even feed foot is great for topstitching which can be spoiled due to irregularity of stitching. Also includes metal quilting guide.

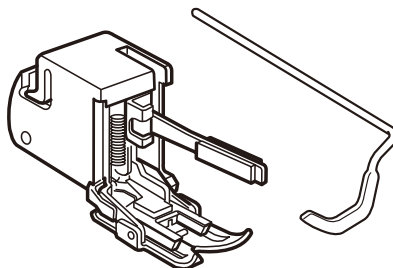

EVEN FEED FOOT WITH QUILTING GUIDE (REGULAR)

200-309-008	A C	BP
200-311-003	DEF	BP
200-310-002	G	BP

EVEN FEED FOOT WITH QUILTING GUIDE (OPEN TOE)

200-338-006	A C	BP
200-339-007	DEF	BP

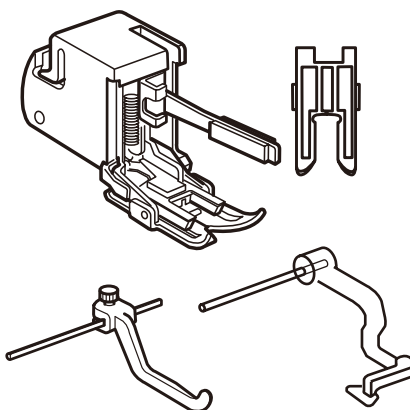

CONVERTIBLE EVEN FEED FOOT SET
The set includes even foot unit, open toe foot, ditch quilting guide and adjustable quilting guide bar.

214-516-003	A	BP
214-517-004	DE	BP
202-133-005	O Q	BP

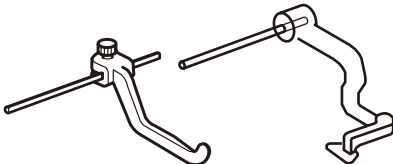

DITCH QUILTING GUIDE AND ADJUSTABLE QUILTING GUIDE SET
A separate quilting guide bar and ditch quilting guide bar set is available for those who already own the even feed foot.

214-518-005	For even feed foot	BP
-------------	--------------------	----

LONG QUILTING GUIDE BAR SET

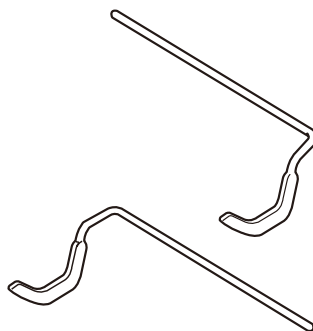

This set includes two guides that can be attached to the left or right of the needle to create parallel rows of stitching approximately two times wider than rows made with the regular quilting guide. Just snap one of the guides into place at the back of the even feed foot and adjust the distance from the needle as required. The guides can also be inserted into a regular foot holder.

202-025-003	A CDEF	NOPQ	BP
-------------	--------	------	----

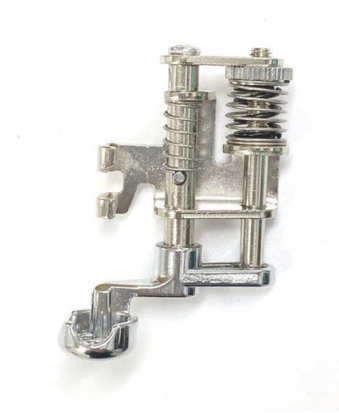

1/4 INCH RULER FOOT

The 1/4 INCH RULER FOOT was specifically designed to use with quilting rulers for ruler work.

The key point of the foot is the 1/4 INCH cup height which moves smoothly alongside the quilting ruler without allowing the ruler to slide over or under the foot.

The needle drops a 1/4 INCH away from the ruler to create the quilting line.

202-442-000	DE	BP
-------------	----	----

202-441-009	A C	OPQ BP
-------------	-----	--------

CONVERTIBLE FREE MOTION QUILTING FOOT SET

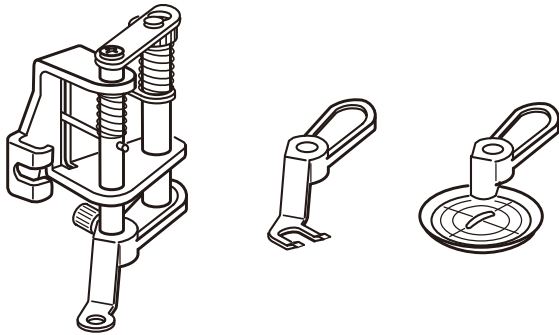

This set includes three feet that can be used with a variety of fabrics for free motion quilting projects. Select the most appropriate foot for the task and attach to the foot holder with a quick screw adjustment. The height of all feet can also be adjusted so they glide effortlessly over layers of fabric.

202-001-003	A C	BP
202-002-004	DE	BP
202-146-001*		NOPQ BP

* Please refer to the table below.

CLOSED-TOE FOOT



Convenient for lace and other fabrics that catch on an open toe, this general use foot is also good for holding the fabric in front of the needle.

OPEN-TOE FOOT



Also for general use, but with greater visibility around the needle to assist formation of a precise design.

CLEAR VIEW FOOT



The clear view foot moves smoothly over uneven layers such as fabric with cording or ribbon, and can also be used with zigzag stitches.

Ordinary sewing

Foot		Closed-toe foot (L)	Open-toe foot (L)	Clear-view foot (L)	Clear-view foot (M)
859A	MC12000	<ul style="list-style-type: none"> • Feed dog: Down • Needle position: Left 	<ul style="list-style-type: none"> • Feed dog: Down • Needle position: Left 	<ul style="list-style-type: none"> • Feed dog: Down • Needle position: Left 	
858F	MC8900QCP				
858G	MC8200QCP				
861A	MC9900				
861AL	MC9850				
862A	HORIZON				
862A2	MC15000				
862F	MC14000				
863AU	Skyline S7				
863F	Skyline S6				
863A	Skyline S5				
862A3	HORIZON Quilt Maker MC15000	<ul style="list-style-type: none"> • Feed dog: Down • Needle position: Left 	<ul style="list-style-type: none"> • Feed dog: Down • Needle position: Left 	<ul style="list-style-type: none"> • Feed dog: Down • Needle position: 1.0 • ZigZag needle plate 	<ul style="list-style-type: none"> • Feed dog: Down
8625A	Skyline S9				
865C	MC9450QCP				
865A	MC9400QCP				
866A	MC6700P				
866D	MC6650				
867	CM7P				
868	CM17				

Sewing application

Foot/ Machine Setting		Closed-toe foot (L)						Open-toe foot (L)						Remarks
		Straight Stitch 1	Straight Stitch 2	Straight Stitch 3	Straight Stitch 4	ZigZag Stitch 1	ZigZag Stitch 2	Straight Stitch 1	Straight Stitch 2	Straight Stitch 3	Straight Stitch 4	ZigZag Stitch 1	ZigZag Stitch 2	
859A	MC12000	No	No	-	-	No	No	No	No	-	-	No	No	
861A	MC9900	No	No	-	-	No	-	No	No	-	-	No	-	Zigzag stitch1: Zigzag
861AL	MC9850	No	No	-	-	No	-	No	No	-	-	No	-	
862A/A2/A3	MC15000	No	No	-	-	No	No	No	No	-	-	No	No	
862F	MC14000	No	No	-	-	No	No	No	No	-	-	No	No	
862SA	Skyline S9	No	No	-	-	No	No	No	No	-	-	No	No	
863AU	Skyline S7	No	No	-	-	No	No	No	No	-	-	No	No	
865C	MC9450QCP	No	No	-	-	No	No	No	No	-	-	No	No	
865A	MC9400QCP	No	No	-	-	No	No	No	No	-	-	No	No	
867A	CM7P	No	No	-	-	No	No	No	No	-	-	No	No	
868A	CM17	No	Yes	No	No	No	No	No	Yes	No	No	No	No	

Foot/ Machine Setting		Clear-view foot (L)						Clear-view foot (M)						Remarks
		Straight Stitch 1	Straight Stitch 2	Straight Stitch 3	Straight Stitch 4	ZigZag Stitch 1	ZigZag Stitch 2	Straight Stitch 1	Straight Stitch 2	Straight Stitch 3	Straight Stitch 4	ZigZag Stitch 1	ZigZag Stitch 2	
859A	MC12000	No	No	-	-	No	No	Yes	No	-	-	Yes	No	
861A	MC9900	No	No	-	-	No	-	-	-	-	-	No	-	Zigzag stitch1: Zigzag
861AL	MC9850	No	No	-	-	No	-	-	-	-	-	No	-	
862A/A2/A3	MC15000	No	No	-	-	No	No	Yes	No	-	-	Yes	No	
862F	MC14000	No	No	-	-	No	No	Yes	No	-	-	Yes	No	
862SA	Skyline S9	No	No	-	-	No	No	Yes	No	-	-	Yes	No	
863AU	Skyline S7	No	No	-	-	No	No	Yes	No	-	-	Yes	No	
865C	MC9450QCP	No	No	-	-	No	No	Yes	No	-	-	Yes	No	
865A	MC9400QCP	No	No	-	-	No	No	Yes	No	-	-	Yes	No	
867A	CM7P	No	No	-	-	No	No	Yes	No	-	-	Yes	No	
868A	CM17	No	No	No	No	No	No	Yes	Yes	×	×	Yes	No	

BOBBIN HOLDER FOR FREE QUILTING AND HAND-LOOK STITCHING

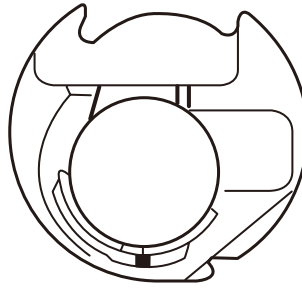

Couple the convertible FMQ foot with this handy bobbin holder preset with lower tension to make it even easier to achieve even tension control.

200-445-007	A C*1	N*4 OP*2 Q	BP
-------------	-------	------------	----

*1 also MC6500P, DC6030, 4120QDC and 3160QDC
 *2 excl. CM7P
 *4 excl. CM17

202-006-008	D		
-------------	---	--	--

202-433-008		N*5	p*3 BP
-------------	--	-----	--------

*3 For use with CM7P only
 *5 For use with CM17 only

FREE MOTION COUCHING FOOT SET

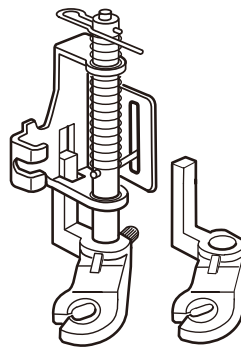

Enjoy embellishing your work with cords, strips and yarns by free-motion stitching. Zigzag stitch makes it easy to sew on any line or shape precisely. Two different feet are included to match material thickness.

202-110-006	A C	NOPQ	BP
-------------	-----	------	----

BORDER GUIDE FOOT

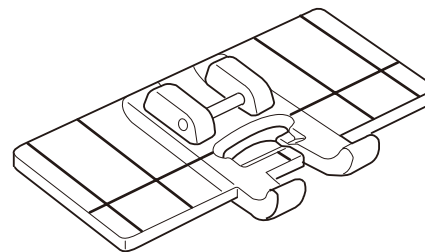

Create evenly spaced rows of decorative stitching with this border guide set. The horizontal red line matches up the needle drop of each row and the vertical red lines allow accurate positioning of one row with another.

200-434-003	A CDEF		BP
202-084-000		NOPQ	BP



BUTTONHOLE STABILIZER PLATE



With the buttonhole foot R attached to the buttonhole stabilizer plate, the machine feeds various kinds of fabric and uneven layers more smoothly instead of eating the fabric or causing the needle to stick in position.

200-428-004	A CDE	BP
-------------	-------	----

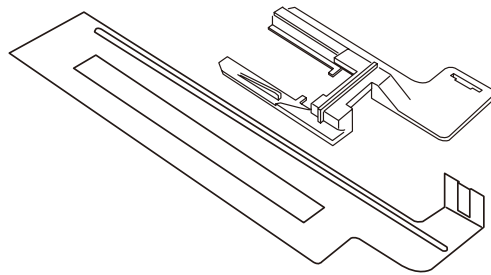

LARGE BUTTONHOLE FOOT AND STABILIZER PLATE

202-199-009	NOPQ	BP
-------------	------	----

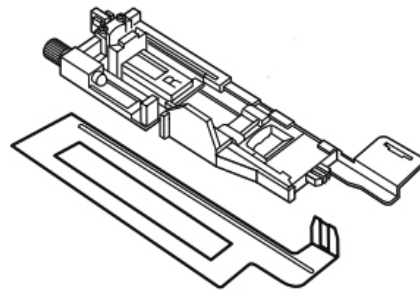

RIBBON SEWING GUIDE

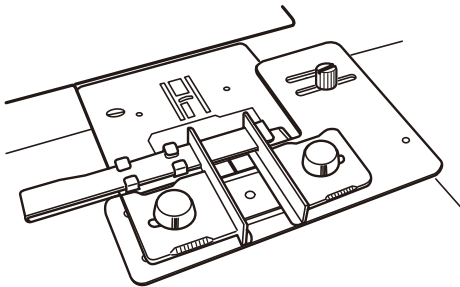

Create original ribbons by adding decorative stitching or lettering. The guide's design ensures easy attachment and automatic centering, while the transparent stabilizer bar provides perfect control. Add originality to projects and make the most of your machine's decorative stitches.

200-444-408	A CDEF	NOPQ	BP
-------------	--------	------	----

EDGE GUIDE FOOT

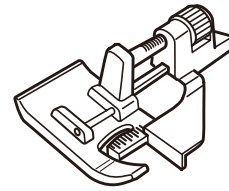

The guide of this foot aligns edges/seams of fabric so that neatly parallel edge stitching and topstitching can be achieved with ease. Adjust the guide by turning the screw to match the edge/seam precisely.

202-147-002	A CDE	BP
202-100-003		NOPQ BP

CIRCULAR ATTACHMENT

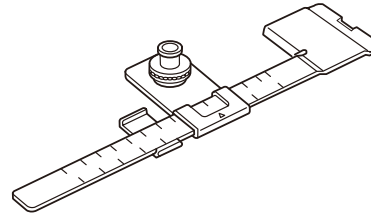

The circular attachment is the ideal attachment for sewing circles using either straight stitch, zigzag, decorative stitches or even lettering. Circles up to 26 cm in diameter are stitched perfectly using this popular attachment so essential for craft and decorative work.

Part Number	Package	Remarks	Compatible Model						
202-106-009	BP	Easy Set Bobbin System is not supported	Harmony 4045/4052	6019QC 6125QC	FD216/212/206 Sew Mini Platinum	M30A	3160QDC 2160DC 2030DC	4120QDC 5120QDC 4300QDC	TS100Q TS200Q
			502	503	508	805	808A/D/F/S/X	809A/AS	811A
			6260QC	MC6600P MC6500P	MC8900QCP MC8200QCP	MC12000	MC11000		
			845	846A/F	858F/G	859A	860		
202-107-000	BP	Easy Set Bobbin System is not supported	M55027 M55021 CS5031 SC5021	Easy Jeans 22 My Style 22	Jem Gold	Jem Gold2	MyExcel 4014/4018 4023/4123	HD2200 MyExcel 18/23	Décor 5124 5024 5018
			505	654	660	661	751	753	757
			Jem Platinum	DC4030	MC8000	MC9000	MC5700 MC5000	MC3500/3000	MC4800
			806	807	830	832	834	840	841
			DC4100	DC3018 DC3030 DC3060 DC8350	MC5200	MC4900	MC10000 MC10001	MC9500	MC9700
842	843	844	847	850	853	857			
202-135-007	BP	Metal Needle Plate with Easy Set Bobbin System is required	5300QDC 5270QDC	M50QDC M100QDC M200QDC	Sewist 780DC 740DC	MC8900QCP SE	MC9900 MC9850	MC15000 MC14000 Skyline S9	Skyline S3/ S5/S6/S7
			809AU/AU2	812	814	858F2	861	862A2/A3/S	863
			MC9450QCP MC9400QCP	MC6700P MC6650	CM7P	CM17			
			865	866	867	868			

BOBBIN HOLDER (high tension for embroidery use)

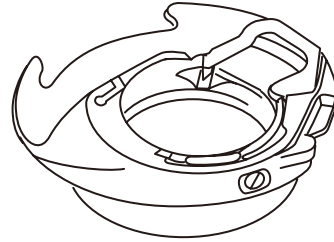

This bobbin holder creates easy-to-adjust thread tension when embroidering with non-Janome bobbin thread. The bobbin holder is marked with a YELLOW dot for identification.

202-134-006	AB ^{*1}	N ^{*3} O	BP
627-569-704	B ^{*2}		NP

*1 MC350E only
 *2 MC300E, MC200E
 *3 excl.CM17

QUILT BINDER SET

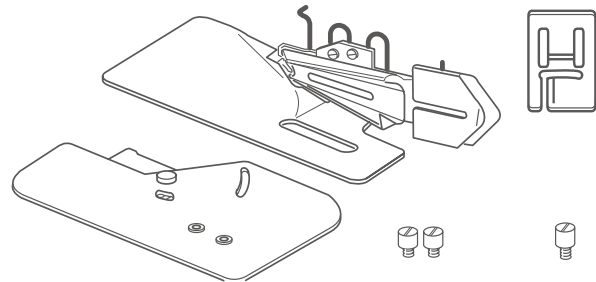

Use the quilt binder set to produce 1/2 inch binding which can handle quilt fabric and other thick fabrics. Adjust the two upper screws to align the binding's top and bottom folds with the needle for extra precision. The set creates straight line binding for large quilts and also adds an eye-catching accent to any small items such as placemats and hot pads.

846-421-007	A C ^{*1}		BP	*1 also MC6500P
202-211-008		NOPQ	BP	

FLOWER STITCHER



Even when using sewing machines without a large number of stitches, this attachment will allow you to produce unique and pretty flower designs and also eyelets, with ease.

202-261-003	DEF		BP
-------------	-----	--	----

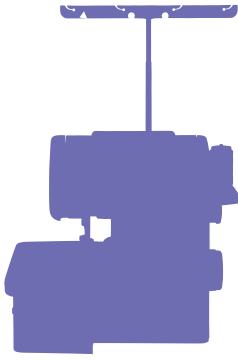

OVERLOCKER ACCESSORIES

Janome overlockers are known for their ease of use and beautiful serging results. Specialized overlocker feet and accessories are designed to give you the effect you want even on stretchy and thin fabrics.

CORDING FOOT (B)



Used in conjunction with the narrow hem, the cording foot B allows you to insert decorative cording as you stitch. This will give fine beautiful finished edges to table and other linens.

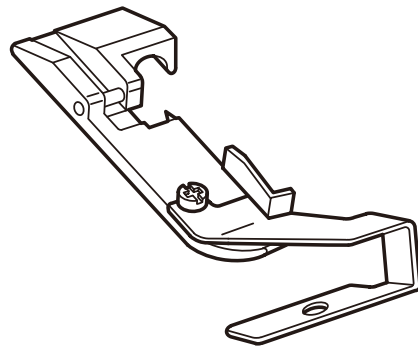

202-035-006	H	BP
-------------	---	----



TAPING FOOT WITH REEL



This attachment consists of a taping foot and a tape reel and is useful when sewing garments in knit or stretch fabric. It will help to feed seam binding tape when sewing shoulder seams and armholes to prevent stretching in these areas.

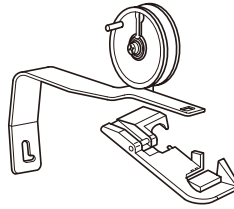

202-033-004	H*1	BP
-------------	-----	----

*1 excl. 234, 234D, AT2000D

BLIND STITCH FOOT



Blind hemming is never an easy technique and demands practice and patience. It is possible to use your overlocker to blind hem and the blind stitch foot is equipped with a guide to help keep your stitching straight.

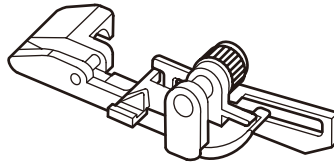

202-040-004	H	BP
-------------	---	----

ELASTIC GATHERING ATTACHMENT



Stitching on elastic can sometimes be a little tricky especially when you have to stretch your elastic to size. The elastic foot helps make this technique a little easier to handle.

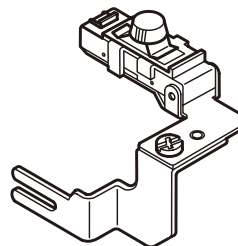

202-037-008	H*	BP
-------------	----	----

* excl. 134D, 234, 234D, 534D

CORDING FOOT (A)

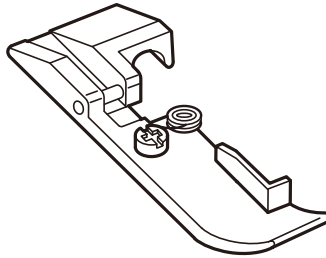

With the rolled hem facility on your machine you can make great use of the cording foot A. This foot is ideal for bridal and evening wear and allows you to insert fine fishing line while rolling the edge of your material giving you a beautiful firm but flexible finish.

202-034-005	H	BP
-------------	---	----

BEADING FOOT

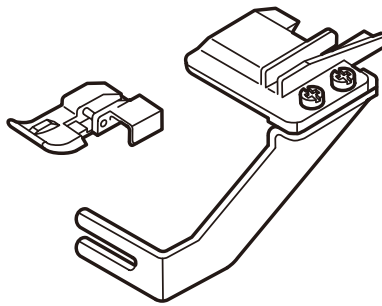

The beading attachment comprises a special sewing foot and guide enabling you to sew strung beads onto the edge of your fabric. Especially attractive for bridal wear.

202-041-108	H*1	BP
-------------	-----	----

*1 excl. 134D, 234, 234D, 534D

WASTE CHIP BOX

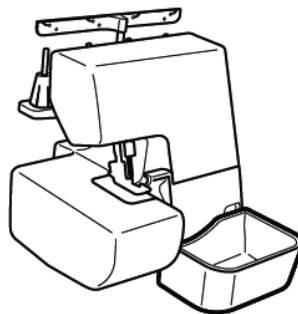

1/pkg

202-456-409	H	CB
-------------	---	----

10/pkg

202-456-708	H	CB
-------------	---	----

20/pkg

202-456-801	H	CB
-------------	---	----

*For use with 8002D, 9102D only

PIPING FEET

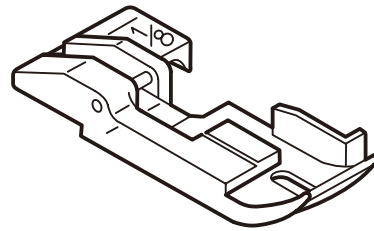

If ready made piping is not available or if you just want to make your own, the piping foot is ideal, making the task quick and easy. The piping foot is available in two sizes: 1/8 inch and 3/16 inch.

SET OF TWO FEET (1/8 inch and 3/16 inch)

202-039-000	H*	BP
-------------	----	----

*3/16 INCH FOOT NOT COMPATIBLE WITH 134D, 234, 234D, 534D

CLOTH GUIDE

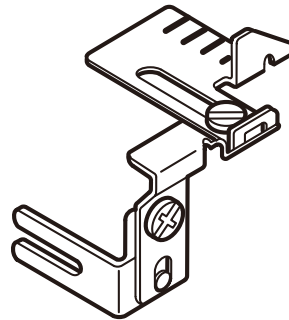

As its name suggests, this guide helps keep your seams straight as you sew. Especially useful on flatlock seams and other seams where the knife is lowered.

202-038-009	H*	BP	* excl. 134D, 234, 234D, 534D
-------------	----	----	-------------------------------

GATHERING ATTACHMENT

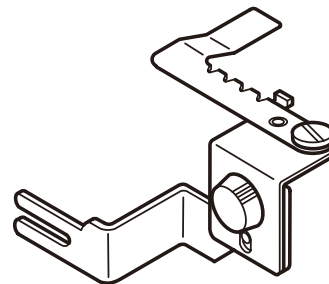

This attachment creates wonderful even gathers. Especially useful when sewing large amounts of fabric, i.e. bed linens and bridal gowns. With the help of this super attachment you can also gather and sew onto a flat piece of fabric in one easy operation.

202-036-100	H*	BP	* excl. 134D, 234, 234D, 534D
-------------	----	----	-------------------------------

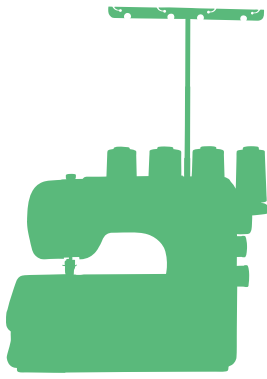

COVER STITCH MACHINE ACCESSORIES

Janome has developed a number of accessories to use with the CoverPro series of cover stitch machines. These accessories make it even easier to create beautiful garments from knits and other stretch fabrics.

CLEAR VIEW COVER STITCH FOOT

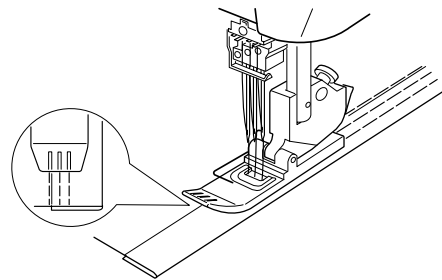

The clear view foot gives you a better view of what you are sewing. It is especially useful for decorative topstitching and can also be used with other attachments such as the hemming guide to match up the end of a hem seam with its start for a beautiful finish. Handy markings on the front edge of the foot correspond with needles for perfect stitch alignment.

for 3 needles	795-818-107	I	BP
for 2 needles	795-821-103	I	BP

HEM GUIDE

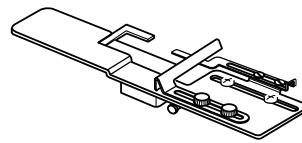

Type 1

The Hem Guide Type 1 folds over a consistent width of fabric for creating cover stitch hems, resulting in straighter hems. The Hem Guide also aids in attaching lace in garment and home decor applications. The guide allows you to create 5/8" - 1 3/4" hems.

795-803-109	I	BP
-------------	---	----

Type 2

The Hem Guide Type 2 folds over a consistent width of fabric for you, making it easy to form hems, cuffs and other finished edges. When sewing the hem of a tubular item such as a skirt, you can press the release button as you near the finish to release the guide and then finish the rest of the hem.

795-839-104	I	BP
-------------	---	----

ELASTIC GATHERING ATTACHMENT

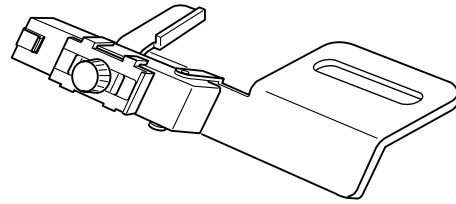

The elastic gathering attachment allows easy attachment of elastic tape for waists and cuffs, which is especially useful for making undergarments and children's clothing. The wide workspace of the CoverPro means you can even add a bit of elastic in the middle of a garment, for example, to the waist of a dress.

narrow (6 - 8.5 mm)	795-816-105	I	BP
wide (9 - 13.5 mm)	795-817-106	I	BP

CENTER GUIDE FOOT

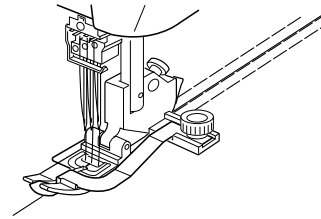

The center guide foot is used for lining up the center of a two or three-needle stitch with a previously sewn seam. This attachment is especially useful on sportswear and allows you to tack down already sewn seams, give extra strength to seams that come under strain or simply give a finished decorative effect.

for 3 needles	795-819-108	I	BP
for 2 needles	795-820-102	I	BP

ADJUSTABLE SEAM GUIDE

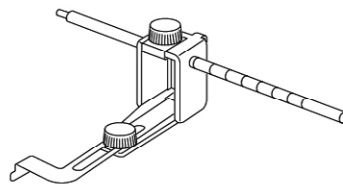

This seam guide is used to sew perfectly placed seams with accurate spacing between the lines.

795-806-102	I	BP
-------------	---	----

TAPE BINDER

The tape binder is used for finishing and covering the raw edges of stretch fabrics. The binder folds the fabric you wish to use as tape around the raw edge as you sew, allowing you to make beautifully finished necks and arm holes and bind any raw edge with ease.

Contents
 Binder and binder plate
 Binder foot
 Screw



for 3 needles (32 mm/8 mm)	795-838-103	I	BP
for 3 needles (42 mm/12 mm)	795-844-009	I	BP
for 2 needles (32 mm/8 mm)	795-840-108	I	BP
for 2 needles (42 mm/12 mm)	795-843-008	I	BP

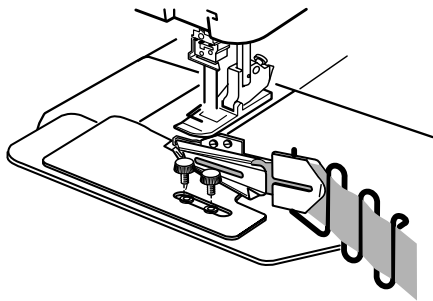

Insert the fabric to be used as tape through the tape guide.



Guide the tape through the tape guide by gently pulling the end with the tip of the tweezers.



Pull out the end while using the tweezers tip to help insert the tape between the upper and lower guides at the end of the tube, and then slide the tape under the presser foot.

TAPE BINDER AND BINDER FOOT WITH GUIDE

This binder set can be used to create a beautiful binder finish like on ready-made T-shirts.

It is the most popular set among optional attachments for cover stitch sewing machines.



Tape Binder (Double Fold 8mm) and Binder Foot with Guide (finished with 8 mm for 32 mm tape)

*Use only the right needle.

Wide Table Binder (Double Fold 12 mm) and Binder Foot with Guide (finished with 12 mm for 42 mm tape)

*Use only the right and center needles.

202-327-008	I	BP
-------------	---	----

202-328-009	I	BP
-------------	---	----

BINDER FOOT WITH GUIDE

This foot gives you a better view and guide is added for ease of use.



796-402-004	I	NP
-------------	---	----

TAPE STAND

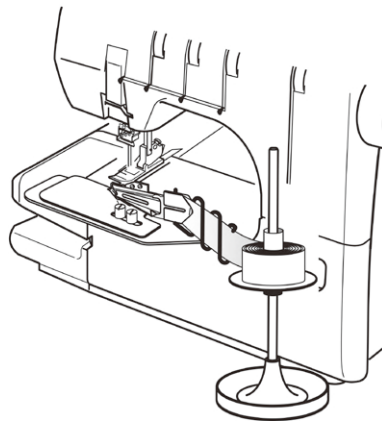

As the tape can be supplied at the same height to the tape guide of the tape binder by using this tape stand with the tape binder, it feeds smoothly even when using very soft fabric allowing beautiful finishes to be achieved.

202-323-004	I	BP
-------------	---	----

BIAS TAPE GUIDE AND BELT LOOP FOLDER



This attachment can be used in two ways: as a "Bias Tape Guide" that can guide bias tape (single fold) and sew it on to knit fabric, and as a "Belt Loop Folder" that can make belt loops from fabric tape. This attachment is useful for creating various types of sewing work.

202-464-008	I	BP
-------------	---	----

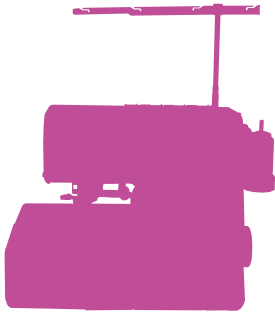

PROFESSIONAL OVERLOCK AND COVER STITCH MACHINE ACCESSORIES

Ready to wear details and decorative accents are easily duplicable with Janome's combined overlock and cover stitch machine accessory range. Create the look you want the way you want it.



GATHERING FOOT

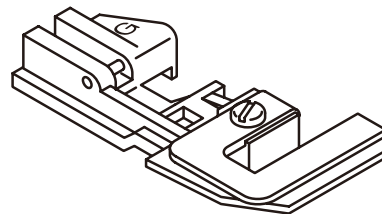

With the gathering foot it's easy to create the gather you want. The bottom fabric is gathered, seamed and overcast to a flat top fabric all in one easy operation.

200-807-104	M	BP
-------------	---	----

BLIND STITCH FOOT

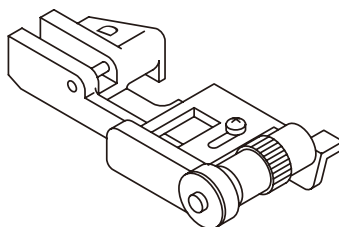
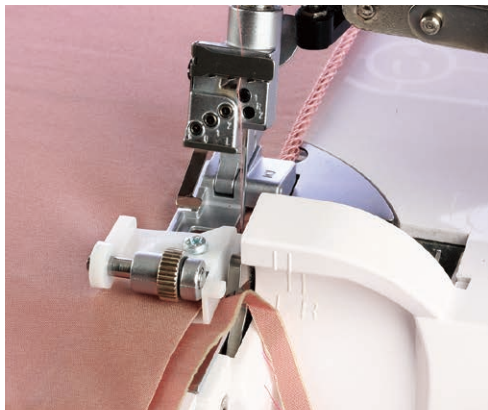

The adjustable guide on the blind stitch foot ensures that any weight of fabric is trimmed, overlocked and invisibly hemmed in one quick step. Change the stitch and it becomes a wonderful guide for decorative pintucks, lacy fagoting or flatlocking as seen in ready to wear.

200-806-103	M	BP
-------------	---	----

BEADING FOOT

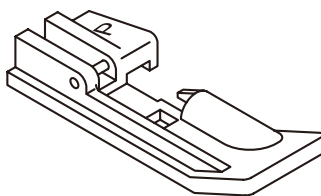

Beaded trims add that special touch to any project. Deep grooves on the bottom of the pearl foot guide strands of pearls or beads perfectly into place and are secured with a flatlock stitch.

200-809-106	M	BP
-------------	---	----





COVER HEM FOOT, LACE ATTACHMENT, HEM & WRAPPED EDGE GUIDES

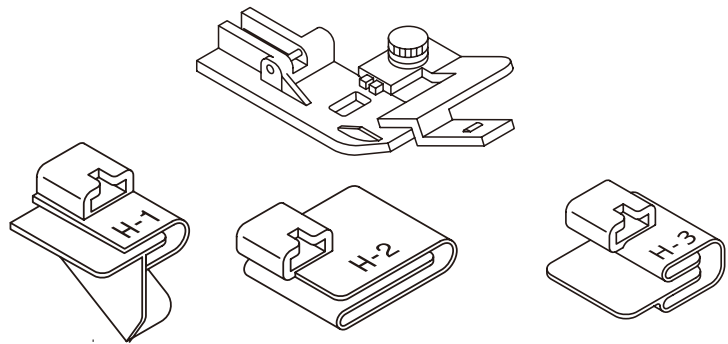

This set will save you a lot of time and trouble by making light work of hems. It offers three different ways to finish the edges of fabric, whether it's making a basic hem, decorating a hem with lace or creating a bias tape finish. Use for a multitude of projects.

200-801-407	M	BP
	<small>(coverhem only)</small>	

COVER HEM FOOT AND LACE ATTACHMENT

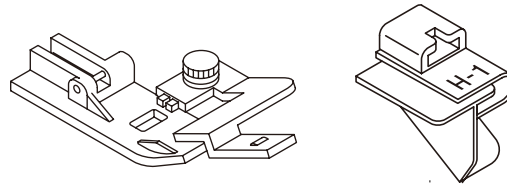

Efficient and clever, this guide folds perfect 6 mm (1/4 inch) edges. At the same moment it's hemming, it attaches lace or trim placed underneath. Use with the cover hem foot.

COVER HEM FOOT AND HEM GUIDE

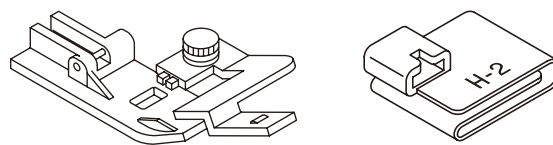

Hem edges evenly without measuring, pinning or pressing. Simply insert the fabric and the guide automatically folds and creates a 2.5 cm (1 inch) hem. Use with the cover hem foot.

COVER HEM FOOT WRAPPED EDGE GUIDE

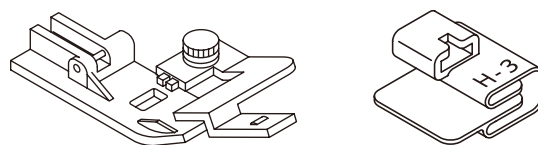

This guide creates the look of bias tape. In addition, it also attaches pre-made bias tape. Hem edges evenly without measuring, pinning or pressing and duplicate ready-to-wear details easily.

BIAS TAPE FOOT

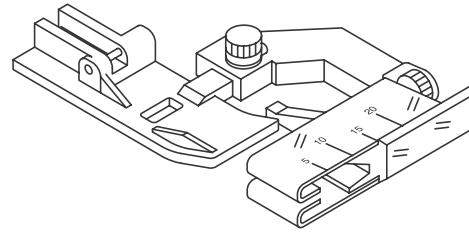
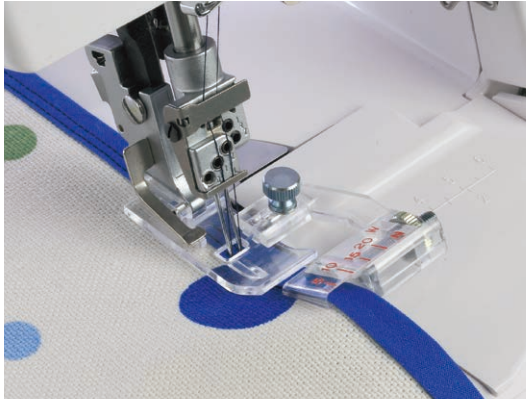

This adjustable foot allows you to attach 10 mm to 40 mm wide bias tape. Creating the look you want has never been easier.

200-810-100	M	BP
-------------	---	----



BELT LOOP FOOT

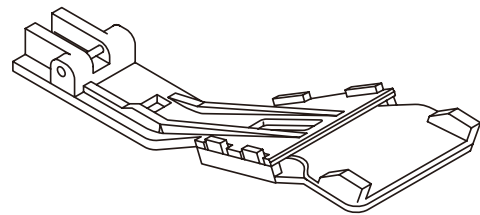
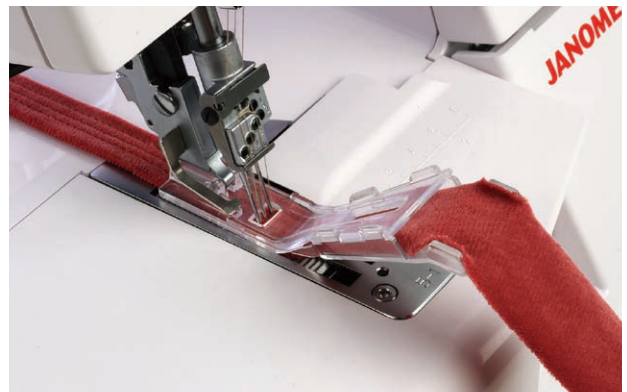

Easily duplicate the belt loops found in the garment industry using a wide or triple cover hem stitch. This foot automatically folds under bias strip edges for belt loops, decorative accents, button loops, narrow straps, etc. The possibilities are limited only by your imagination.

200-808-105	M	BP
-------------	---	----

(coverhem only)



HIGH SPEED MACHINE ACCESSORIES

Janome high speed sewing machines sew at a maximum 1,600 stitches per minute, the fastest on the market. Everything on these sewing and quilting machines is built for high quality stitches at professional speeds, including the specialized accessories and presser feet.

ULTRA GLIDE FOOT

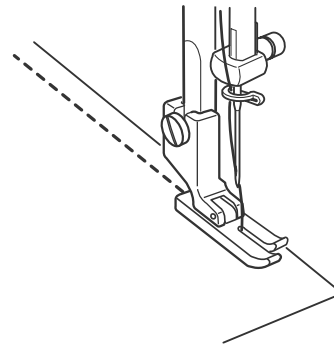
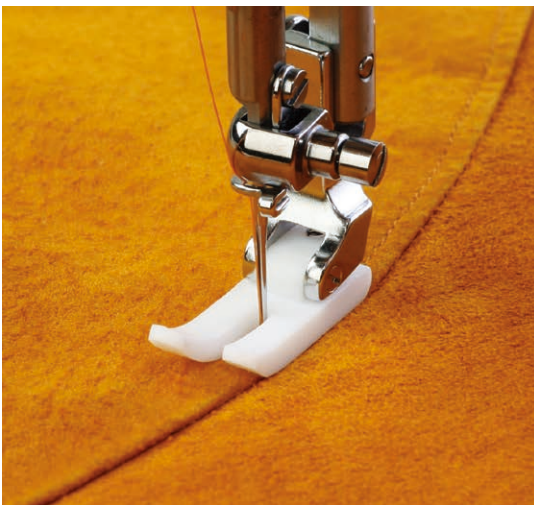

Molded from a special resin for easy sewing of fabrics that might stick to a metal foot, the ultra glide foot is perfect for sewing ultra suede, vinyl and imitation leather.

767-404-028	J	BP
-------------	---	----

HD ROLLER FOOT



An innovative new foot that can smoothly control materials such as leather and vinyl which are prone to catch. When using this foot, the base of the needle is clearly visible, making your work easier.

202-418-007	A C	J	NOPQ	BP
-------------	-----	---	------	----

SPECIALIZED STRAIGHT STITCH FEET

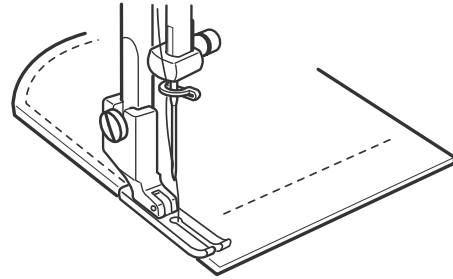

NARROW STRAIGHT STITCH FOOT

This foot is only 2 mm wide from the needle drop to the edge of the foot making it convenient for narrow topstitching especially on areas such as collars and pockets.

767-406-019	J	BP
-------------	---	----

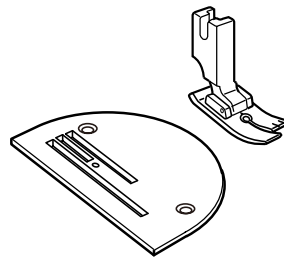

STRAIGHT STITCH FOOT AND NEEDLE PLATE FOR FINE FABRICS

The specialized foot and needle plate work together to provide optimal feeding of fine fabrics.

767-405-007	J	BP
-------------	---	----

VELVET FOOT

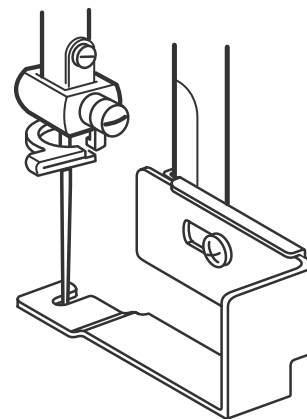

The velvet foot only slightly touches the needle plate when the foot is lowered to obtain perfect sewing without bruising the specialty fabrics.

767-407-102	J	NP
-------------	---	----



1/4 INCH SEAM FOOT

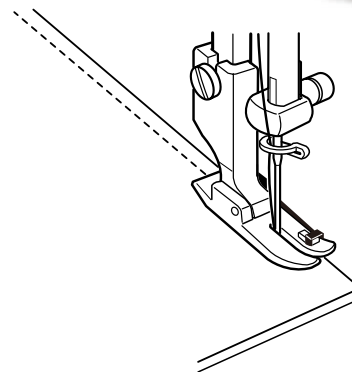

The side guide allows you to sew a 1/4 inch seam allowance quickly and accurately. Great for piecing quilts and topstitching.

767-820-105 J BP

DITCH QUILTING FOOT

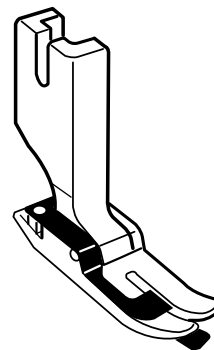

Use this foot for perfect placement when stitching in the ditch. The guide follows the seamline keeping the stitch line perfectly straight.

767-824-109 J BP

EVEN FEED FOOT

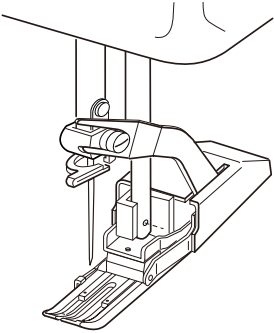

The even feed foot walks over fabric to assist with smooth feeding. Fabric can be sewn without puckering as the fabric is gripped and fed by both the upper and lower feed dogs. This foot has been specially designed for durability and to work at the high speeds of the 1600 series.

767-403-016	J	BP
-------------	---	----

DARNING FOOT WITH DARNING PLATE

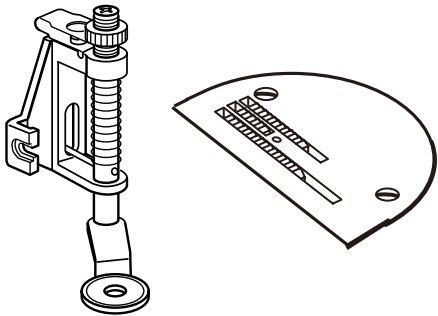

The spring loaded foot can be used for free motion stippling, quilting and free form monogramming. The darning plate is placed over the existing needle plate to cover the feed dogs.

767-827-009	J	BP
-------------	---	----

TAPING FOOT

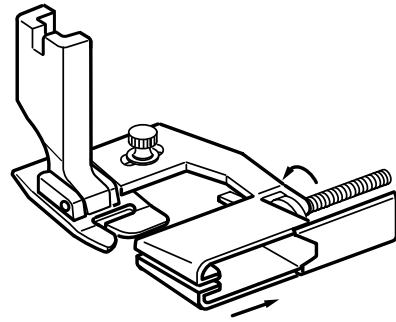

Use this foot for attaching tape to the edge of fabrics. Adjust the needle drop position with the thumb screw. Guide the fabric with the left hand and tape with the right hand.

767-412-018	J	BP
-------------	---	----

ADJUSTABLE ZIPPER FOOT

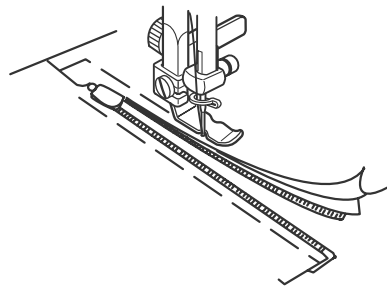
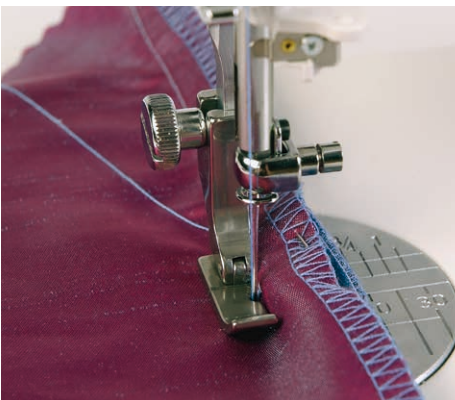

This foot can be set to sew on each side of the zipper by adjusting the position of the foot and tightening the thumb screw. Also great for sewing close to piping.

767-408-011	J	BP
-------------	---	----

CONCEAL[®] ZIPPER FOOT

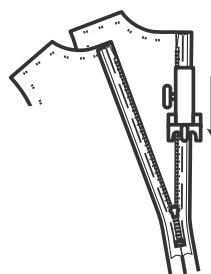
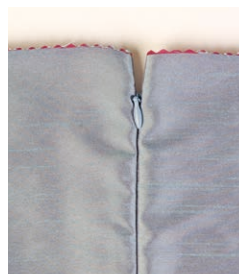

This foot can be used for placement of invisible zippers. The grooves underneath accommodate the zipper teeth and hold them in place while you stitch.

767-410-016	J	BP
-------------	---	----

CONCEAL is a registered trademark of YKK Corporation.

ADJUSTABLE SEAM GUIDE

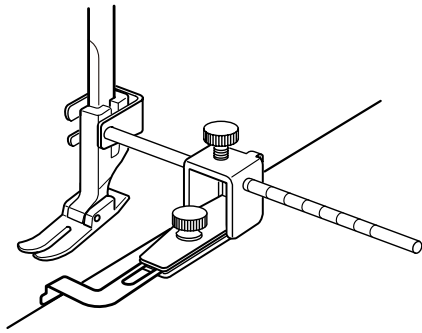

This seam guide is used to sew perfectly placed seams with accurate spacing between the lines.

767-411-017	J	BP
-------------	---	----

CONVERTIBLE FREE MOTION QUILTING FOOT SET

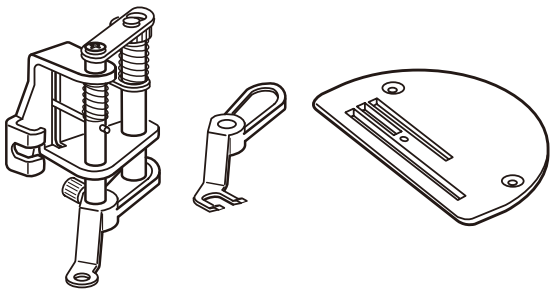

An exciting free-motion quilting presser foot set for the straight stitch machine. The feet are streamlined for improved visibility and a darn plate is also provided for table top free-motion quilting. The industrial construction reduces vibration and provides professional-level durability.

767-433-004	J	BP
-------------	---	----



For general use and especially well suited for lace and other catchable fabrics.



Also for general use, but the open-toe design provides greater visibility around the needle to assist in the formation of a precise design.



FREE MOTION FRAME QUILTING FEET SET

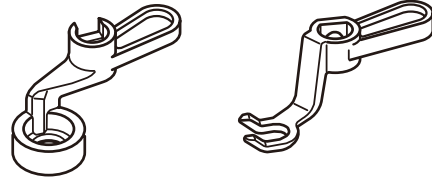

This set has been specifically designed to support quilters who use quilting frames with the 1600P series. The set consists of a 1/4 inch ruler foot and an open-toe frame quilting foot.

767-434-005	J	BP
-------------	---	----



This open-toe foot has an opening that faces sideways to provide a clear view of your work when standing at the handles of a quilt frame.



The 1/4 inch ruler foot has a high 'heel' and 1/2 inch diameter for free-motion quilting with 1/4 inch thick quilt rulers and long arm quilting templates.

1/4 INCH RULER FOOT SET

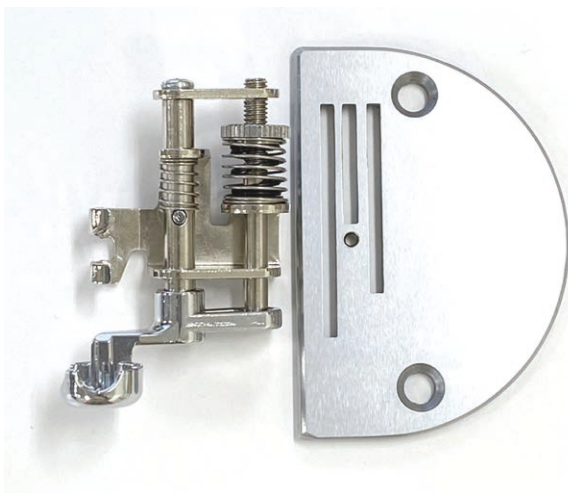

The 1/4 INCH RULER FOOT was specifically designed to use with quilting rulers for ruler work. The key point of the foot is the 1/4 INCH cup height which moves smoothly alongside the quilting ruler without allowing the ruler to slide over or under the foot. The needle drops a 1/4 INCH away from the ruler to create the quilting line.

* This set includes a needle plate.

767-441-005	J	BP
-------------	---	----



NEEDLE PUNCHING

Discover the ancient art of felting, and unleash your artistic potential.

Felting uses barbed needles to interweave two or more fibers, blending their colors and textures to create a completely new and unique material, without thread or bobbin. For centuries, fabric artists have felted by hand, a painstaking and inexact process. With a dedicated felting or needle punching machine, you can master this art in minutes, and achieve professional-looking results with ease.



1 Needles do the Work

There is no thread or bobbin mechanism involved. Instead, these sharp needles have barbs that catch the fibers of the fabrics and push them down through the layers.

2 Five-Hole Design

The needle holes in the base plate keep fabric in place, help the needles penetrate multiple layers and prevent fabric munching.

3 Room for Multiple Layers

The see-through adjustable presser foot allows you to manipulate multiple layers.

4 Extended Range of Needle Units

Multiple needle units to deal with a variety of felting situations.

Single needle (fixed) unit

725-810-009*	K	NP
--------------	---	----

Five needle (fixed) unit

725-607-104*	K	NP
--------------	---	----

Needle unit with presser foot including five needle (replaceable) unit

725-822-004	K	BP
-------------	---	----

5 Two Needle Sizes

Vary your finishes with different sized needles for use with the five needle (replaceable) unit.

Standard needle refill (10 pcs./set)

725-807-003*	K	NP
--------------	---	----

Fine needle refill (10 pcs./set)

725-831-006*	K	NP
--------------	---	----

* In a plastic case

Explore the creative possibilities!

Fabric Scraps



Novelty Yarns

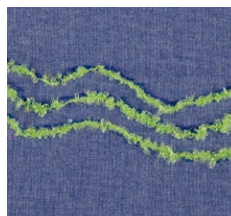

Variegated Colors



Roving



Ribbons and Lace





Endless possibilities with your materials

You can use almost any fabric, yarn or other material for endless variety in your work. Create soft-edged effects in your favorite colors with yarn or roving (un-spun fiber), or make a collage effect by combining these materials with ribbon, lace and other textiles. Enjoy the chance to experiment and discover a whole range of effects that will compliment and enhance all kinds of items.

Different needles for even more effects

Enjoy combining the technique of needle punching with embroidery and decorative stitching to give added color, texture and dimension to clothes and accessories, and to provide eye-catching accents.

You can experiment with the number and thickness of needles to create a variety of finishes depending on the material. JANOME Fine Needles make a denser felt and are ideal for delicate or precise work.



Totally unique accessories

Create one of a kind items from scratch by making your own original felted fabric. The JANOME Changeable Needle Unit allows for individual needle replacement, so even if a needle breaks during long periods of use, it can be replaced. This means more flexible and economical use.

MISC. ACCESSORIES

From basic accessories like needles, bobbins and bobbin cases to items such as spool stands which expand the creative possibilities of your sewing machine, Janome is dedicated to providing you with high quality accessories that are easy to use.



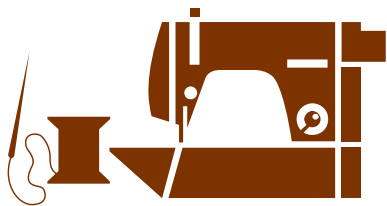

NEEDLES

No matter how advanced or sophisticated the sewing machine has become, the basic principle of selecting the correct needle to be used must still apply. Quite simply, the finer the fabric the finer the needle, the heavier the fabric the heavier the needle, but whether fine or heavy it is important to replace your needles regularly.



ASSORTED SEWING NEEDLES

200-135-001		
ABCDEF	G	NOPQ BP

A set of five general sewing machine needles with two size #75/11 regular type needles, two size #90/14 regular type needles and one Blue Tip needle.



BLUE TIP NEEDLES

200-346-007		
ABCDEF	G	NOPQ BP

The Blue Tip needle, a Janome exclusive, is a size #75/11 needle and is our best "all purpose" needle for both machine embroidery and general sewing including the sewing of knit fabrics. It features a ball point tip* which helps to create neat and tidy stitches.



RED TIP NEEDLES

990-314-109		
ABCDEF	G	NOPQ BP

The red tip needle is a #90/14 size needle and is for general sewing and for embroidery of medium to heavy fabrics.



PURPLE TIP NEEDLES

202-122-001		
ABCDEFGH		NOPQ BP

The purple tip needle is a #90/14 size needle that prevents skipped stitches in heavy fabrics including knits in ordinary sewing and when embroidering. It features a ball point tip* which helps to create neat and tidy stitches.

Uses -

- Embroidery with high density designs and/or thick fabrics
- Use with fluffy threads like cotton
- Quilting through multiple layers
- Normal sewing for shrink fabrics such as knits and tricot or synthetic fabrics such polyester

*The ball point tip is especially useful when sewing knitted fabric and synthetic fabric as it prevents fabric thread breakage.

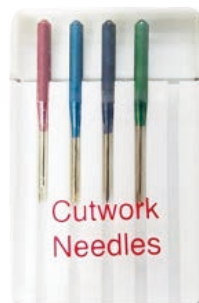

CUTWORK NEEDLE SET

202-200-004		
	N	BP

*excl. MC12000

This set contains 4colorcoded needles with the following cutting angles:

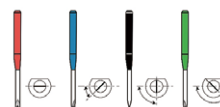

CUTWORK NEEDLE HOLDER

862-402-301		
	N	NP

*excl. MC12000

The Cutwork Needle Holder allows you to safely replace the Cutwork needles without injuring yourself with the tip of the Cutwork needle.

Model	Needle Type	Part Number	Category	Package
Ball Point for Sewing machines and Overlockers	HA15x1SP Ball point assorted (5/pkg)	990-200-000	ABCDEFGHIH NOPQ	Needle case
	HA15x1SP Ball point size 75/11 (5/pkg)	990-211-000	ABCDEFGHIH NOPQ	Needle case
	HA15x1SP Ball point size 90/14 (5/pkg)	990-214-000	ABCDEFGHIH NOPQ	Needle case
CoverPro	Assorted 80/12 & 90/14 (5/pkg)	795-802-108	I	BP
	Size 80/12 (5/pkg)	795-807-103	I	BP
	Size 90/14 (5/pkg)	795-808-104	I	BP
1600P	HLx5 size 65/9 (10/pkg)	767-811-000	J	BP
	HLx5 size 75/11 (10/pkg)	767-812-001	J	BP
	HLx5 size 90/14 (10/pkg)	767-813-002	J	BP
	HLx5 size 100/16 (10/pkg)	767-814-003	J	BP
1600P-DB & 1600P-DBX	DBx1 size 65/9 (10/pkg)	767-807-003	J	BP
	DBx1 size 75/11 (10/pkg)	767-808-004	J	BP
	DBx1 size 90/14 (10/pkg)	767-809-005	J	BP
	DBx1 size 100/16 (10/pkg)	767-810-009	J	BP
MB-4	Embroidery needles (10/Pkg)	770-811-000	L	Paper bag



FM725 CHANGEABLE NEEDLE UNIT

725-822-004	
K	BP



FM725 FIXED FIVE FELTING NEEDLE UNIT

725-607-104*	
K	NP



FM725 FIXED SINGLE FELTING NEEDLE UNIT

725-810-009*	
K	NP



FM725 NEEDLE REFILLS

single needle refills
3/pkg

725-811-000*	
K	NP

5/pkg

725-829-001*	
K	NP

10/pkg

725-807-003*	
K	NP

fine needle refills
10/pkg

725-831-006*	
K	NP

* In a plastic case



OTHER ACCESSORIES

CLOTH SETTER



The patented Clothsetter has taken the guesswork out of positioning your embroidery. It ensures perfect placement of single designs on your project and multiple designs within the same hoop or between multiple hoopings. It's so easy, and only Janome has it. This dual function tool converts quickly into a large extension table providing extra support for all your large sewing and quilting projects.

CLOTH SETTER for MC15000/MC12000/MC9900/
MC550E/MC500E/MC400E

859-439-101	B *1	NO	CB
-------------	------	----	----

*1 For use with MC550E,MC500E,MC400E only



CLOTHSETTER TABLE - for MC11000

860-401-005	A	CB
-------------	---	----

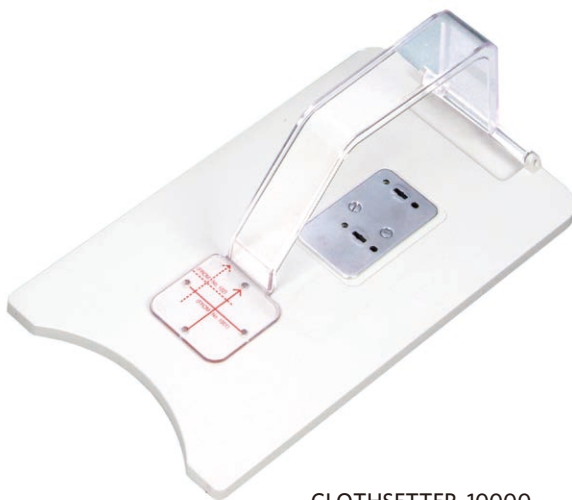

CLOTHSETTER 10000

850-402-005	A	CB
-------------	---	----

UNIVERSAL TABLE STAND

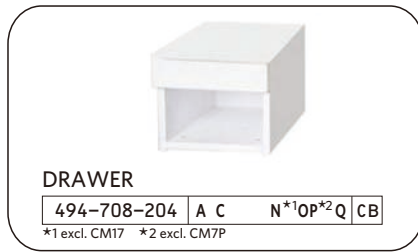

Machines can sit in the table stably, with an insert plate filling the remaining space to provide a large, flat sewing surface. Not only is there more work space, but the table helps sewing progress smoothly by preventing excess fabric from dangling down and interfering with your work. It accommodates the knee lifter, contains a drawer and offers a generous formica-finished sewing surface.

INSERT PLATE-A FOR HORIZON SERIES

494-401-101	C*1	N*2P	CB
-------------	-----	------	----

*1 excl. MC6600P *2 MC12000 only

INSERT PLATE-B FOR MC6600P/MC6500P

494-402-102	C*3D*4	CB
-------------	--------	----

*3 excl. MC7700QCP *4 MC6500P only

INSERT PLATE-C FOR MC11000/MC11000SE

494-403-103	A	CB
-------------	---	----

INSERT PLATE-D FOR MC9900

494-405-105	O	CB
-------------	---	----

INSERT PLATE-E FOR MC15000

494-406-106	N*5	CB
-------------	-----	----

*5 MC15000 only

INSERT PLATE-F FOR SKYLINE & ATELIER SERIES

494-407-107	Q	CB
-------------	---	----

INSERT PLATE-G FOR MC9450/MC9400

494-408-108	P*6	CB
-------------	-----	----

*6 For use with MC9450/MC9400 only

INSERT PLATE-H FOR MC6700P

494-712-005	P*7	CB
-------------	-----	----

*7 For use with MC6700P only

UNIVERSAL TABLE STAND FOR CM17 & CM7P



UNIVERSAL TABLE STAND WITH DRAWER

494-719-002	N*1P*2	CB
-------------	--------	----

*1 For use with CM17 only *2 For use with CM7P only

INSERT PLATE-K FOR CM17 & CM7P

494-411-104	N*1P*2	CB
-------------	--------	----

*1 For use with CM17 only *2 For use with CM7P only

SIDE TABLE STAND UNIT



This table is useful for any type of sewing. Place embroidery machines or overlockers on the table to secure more work space. Can also be used in combination with the universal table stand as a quilt side table and/or just to provide extra space for ironing, cutting fabrics or other activities. Comes with side pockets.

494-709-009	ABCDEFGHIJKLMNO P Q	CB
-------------	---------------------	----

BRUSH-OUT EMBROIDERY KIT



Brush-out embroidery uses yarn which can be fluffed up after sewing to create a soft, three-dimensional finish. The Brush-Out Embroidery kit includes a special foot and brush and is designed for use with the Brush-Out Embroidery Design CD-ROM from Stitchitize.

200-383-006	A B	BP
-------------	-----	----

EMBROIDERY COUCHING FOOT SET



The Embroidery Couching Foot Set includes 2 feet for using different yarn weights, a yarn guide arm that attaches to the extra spool pin hole on the top of the machine, plus instructions on How-to-use this foot set.

202-316-004	B *1	BP
202-297-008	N *2	BP

*1 For use with MC550E, MC500E, MC450E and MC400E only
 *2 For use with MC15000, Skyline S9 only

LARGE EMBROIDERY DESIGN COLLECTION

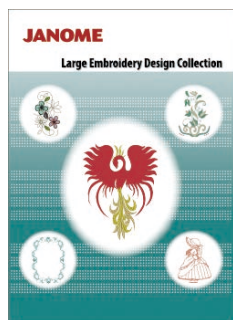

Large Embroidery Collection comes with a USB flash drive containing 30 embroidery designs.

202-295-006	B *1	N *2	CB
-------------	------	------	----

*1 excl. MC400E, MC350E, MC300E, MC200E
 *2 excl. Skyline S9

BOBBINS



The metal bobbin is suitable for Janome front and side-loaded professional-level machines including the 1600 series and MB-4. The clear plastic bobbin is compatible with all other Janome sewing and embroidery machines.

PLASTIC BOBBINS (10/pkg)	200-122-005	ABCDEFG	NOPQ	BP
METAL BOBBIN (single)	761-094-104		J L	NP

SPECIALIZED BOBBIN

Designed for Memory Craft embroidery and computerized models. Rubber added to the clear resin improves performance and reduces noise. Imprinted with letter 'J.'

PLASTIC BOBBIN (single)	102-261-103	ABCD	NOPQ	NP
-------------------------	-------------	------	------	----

PINK BOBBIN



200-277-062	ABCDEFG	NOPQ	NP
-------------	---------	------	----

BLUE BOBBIN



200-277-084	ABCDEFG	NOPQ	NP
-------------	---------	------	----

BOBBIN CASES



Front and side-loading machines require a separate bobbin case which also acts to control the bobbin tension. Although not generally recommended, more advanced sewists like to adjust the lower tension to accommodate special threads, such as when using a handwound bobbin of thicker decorative thread. You can avoid tricky tension adjustments afterwards by having an extra bobbin case on hand specially adjusted for thicker or thinner threads.

HOUSEHOLD SEWING	647-515-006	G	NP
HIGH SPEED SEWING	767-510-006	J	NP
MULTI-NEEDLE EMBROIDERY	770-038-005	L	NP

SPOOL HOLDER (SPECIAL)



Have you had times when you're putting a long spool on the horizontal spool stand but the spool pin is short and the spool holder can't be attached?

Janome has come up with a solution for this by developing a new spool holder.

The "Spool Holder (special)" is specifically for long spools.

202-233-006	ABCDEFG	NOPQ	BP
-------------	---------	------	----

PROTECTIVE SHEET



A sheet to protect the stainless steel plate on the free arm top from scratches and damage. Being transparent, it doesn't interfere with the exterior design and allows the embossed measurement guide to still be used.

859-434-003		N*1	BP
-------------	--	-----	----

*1 For use with MC15000 and MC12000 only

REMOTE THREAD CUTTING SWITCH UNIT



Cut threads by foot after sewing. A useful tool for when both hands are occupied, allowing you to focus on the fabric. Can also be helpful when the machine is placed on a quilt frame, making your work more efficient.

858-418-008		OP*1Q	CB
-------------	--	-------	----

*1 excl. MC8200QC

* Should be used with the large foot controller only. Not included in set (sold separately).

LARGE FOOT CONTROLLER



Now bigger and easier to use. As rubber covers the back face, it won't slip and is simple to operate. The larger surface facilitates a greater level of control.

858-417-007	A CD	NOPQ	CB
-------------	------	------	----

PIN CUSION



202-256-005	AC*1	DN*2	OP*3	Q*4	NP
-------------	------	------	------	-----	----



202-256-027	AC*1	DN*2	OP*3	Q*4	NP
-------------	------	------	------	-----	----



202-256-016	AC*1	DN*2	OP*3	Q*4	NP
-------------	------	------	------	-----	----



202-256-038	AC*1	DN*2	OP*3	Q*4	NP
-------------	------	------	------	-----	----

*1 excl. MC6600P, MC6500P
 *2 excl. CM17
 *3 excl. MC6700P, CM7P
 *4 excl. MC6650

NET



624-806-006	ABCDEFGHIJKLMNO P Q	NP
-------------	---------------------	----

SEWING MAT



445 mm X 325 mm	301-802-002	A*1	DEFGHI K M	NP
-----------------	-------------	-----	------------	----

*1 MC8000, MC5700 and MC5000 only



370 mm X 610 mm	301-803-003		L	NP
-----------------	-------------	--	---	----

STRAIGHT STITCH NEEDLE PLATE

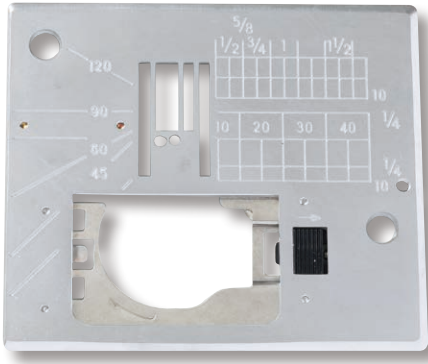

The straight stitch needle plate is designed with a round needle hole which offers the benefit of more support around the needle and is used in conjunction with the straight stitch foot.

Part Number	Package	Standard or Optional	Compatible Model	Max. zigzag width	Needle Position	Easy Set Bobbin	One-Touch Needle Plate Conversion	Remarks
503-820-008	NP	Optional	6125QC/6019QC	7 mm	L,M	No	No	
860-405-906	CB	Optional	MC11000/4300QDC/4120QDC/3160QDC/2160DC/ 2030DC/TS200Q/TS100Q	7 mm	L,M	No	No	Metal Needle Plate without Easy Set Bobbin System is required
			860/809/808/811					
809-833-012	NP	Optional	DC7100/DC7060/ DC6030/5300QDC/5270QDC/5060QDC/ Sewist 780DC/740DC/TS200Q/M200QDC	7 mm	L,M	Yes	No	Metal Needle Plate with Easy Set Bobbin System is required
			809/814/812					
200-088-101	NP	Optional	MC3000/MC4000/MC9000/MC9500/MC9700	7 mm	L,M	No	No	
846-833-109	NP	Optional	MC6600P	7 mm	L,M	No	No	
861-801-013	NP	Standard	MC9900	9 mm	L, M	Yes	Yes	
		Optional	MC9850					
862-817-118	NP	Standard	MC8900SE/MC8200SE/Skyline S9/S7/S6/S5/ MC9450/MC9400/MC6700P/MC6650	9 mm	L, M, R	Yes	Yes	
865-805-019	NP	Standard	MC9450/MC9400/Skyline S9/MC6700P/MC6650	9 mm	L	Yes	Yes	HP Needle Plate
859-831-015	NP	Standard	MC12000/MC8900/MC8200	9 mm	L, M	No	Yes	
865-805-112	NP	Standard	Quilt Maker MC15000	9 mm	L	Yes	Yes	HP Needle Plate
		Optional	MC15000/MC15000V2					
862-817-015	NP	Standard	MC15000/MC15000V2/Quilt Maker MC15000/ MC14000	9 mm	L, M, R	Yes	Yes	
867-802-001	NP	Standard	CM7P/CM17	9 mm	L, M, R	Yes	Yes (Magnet type)	
867-803-002	NP	Standard	CM7P/CM17	9 mm	L	Yes	Yes (Magnet type)	HP Needle Plate

OPTIC MAGNIFIER



When you need to get a closer view, attach the magnifier to make it easy to see the tiniest detail under the needle. Useful when threading, adjusting the position of the fabric, and carrying out detailed work.

Part Number	Package	Holder	Strength	Compatible Model	
				Optional Accessory	Standard Accessory
202-129-008	BP	Short	20	DC7100/DC7060/DC6030/5060QDC/ DC3200	MC12000
202-130-002	BP	Long	20/40/60	MC9450QCP/MC9400QCP MC8900QCP/MC8200QCP/MC6700P MC9900/MC9850/MC6650 Skyline S9/S7/S6/S5/S3 Sewist 780DC/740DC 5300QDC/5270QDC/4300QDC M200QDC/M100QDC/M50QDC TS200Q*/TS100Q*	MC15000
202-400-006	BP	Long	20		MC14000
202-432-007	BP	Long	20/40/60	CM7P	CM17

*1 Holder (#859-233-000) and Setscrew 3x10(#000-161-206) are required for TS200Q/TS100Q(811)

SKYLINE ACCESSORY CASE



Keep all the accessories for 9mm machines organized with this stylish 3-tiered accessory case. Everything from AcuFeed Flex™ parts to bobbins and presser feet can be kept neat and clean in its own place.

* Accessories not included

863-406-009	N*1P*2	CB
-------------	--------	----

*1 SkylineS9 only

*2 For use with SkylineS6, Skyline7

EMBROIDERY HOOP



Part Number	Package	Hoop Name		Size (mm)	Compatible Model
				X × Y	
856-401-002	CB	Small		50 × 50	MC200E
850-803-000	CB	C	Free Arm	50 × 50	MC350E
850-406-009	CB	D	Giga	230 × 200	
850-413-009	CB	F	Round	127 × 110	
864-839-008	NP	RE36b	Rectangular	200 × 360	MC550E(Standard Accessory)
864-403-009	CB	RE28b	Rectangular	200 × 280	MC550E/MC500E/MC450E
864-404-000	CB	SQ20b	Square	200 × 200	MC550E/MC500E/MC450E/MC400E
864-405-001	CB	RE20b	Rectangular	140 × 200	MC550E/MC500E/MC450E/MC400E
864-406-002	CB	SQ14b	Square	140 × 140	MC550E/MC500E/MC450E/MC400E
864-407-003	CB	RE10b	Rectangular	100 × 40	MC550E/MC500E/MC450E/MC400E
864-435-000	CB	ASQ18b	AcuFil Quilting Kit	184 × 184	MC550E/MC500E/MC450E/MC400E
864-402-008	CB	ASQ18b	AcuFil Quilting Kit	184 × 184	MC500E/MC450E/MC400E
861-402-205	CB	FA10a	Free Arm	100 × 40	Skyline S9/MC9900/MC9850
860-427-007	CB	FA	Free Arm	50 × 50	MC11000SE
860-428-008	CB	MA	Macro	200 × 280	
860-421-001	CB	RE	Rectangular	140 × 200	
860-445-012	CB	ASQ	Professional Quilting Kit	180 × 180	
862-412-005	CB	ASQ22	AcuFil Quilting Kit	220 × 220	MC14000/MC12000
862-407-052	CB	RE18	Essential	140 × 180	MC15000/MC14000
770-487-704	NP	J1 No.11		30(diam.)	MB-7/MB-4S/MB-4 *Monogram Hoop Adaptor (770-482-008) is required when using hoops J1-J8
770-487-807	NP	J1 No.12		30(diam.)	
770-487-302	NP	J2 No.6		24 × 54	
770-487-900	NP	J3 No.13		64 × 28	
770-487-508	NP	J4 No.8		42 × 67	
770-487-209	NP	J5 No.3		46 × 46	
770-487-106	NP	J6 No.2		66 × 66	
770-487-601	NP	J6 No.9		100 × 40	
770-487-003	NP	J7 No.1		100 × 40	
770-487-405	NP	J8 No.7		100 × 40	
770-478-414	NP	S1:MB		37 × 59	MB-7/MB-4S/MB-4 *Socks Hoop Adaptor (770-657-006) is required when using hoops S1, S2
770-478-517	NP	S2:MB		28 × 50	
770-480-006	CB	Sock Hoop Kit			

Part Number	Package	Hoop Name	Required Hoop Size (mm)	Compatible Model
200-335-003	Plastic bag	Hat Hoop Insert (HH10b)	140 × 200	MC550E/MC500E/MC450E/MC400E/MC300E/MC350E MC9500/MC9700/MC11000SE
859-436-005	Plastic bag	Hat Hoop Insert	140 × 140	MC15000/MC14000/MC12000
770-489-005	Plastic bag	Flat hat Hoop	Not required	MB-7/MB-4S/MB-4

EXTRA WIDE TABLE



An Extra wide table fits snugly against your sewing machine, giving you a much larger work surface. Extra wide tables provide extra support for your sewing and quilting projects.

Part Number	Package	Compatible Model				
303-403-005	CB	423S/419S/415/405 303				
306-502-004	CB	3012/3016/3022 306				
725-813-002	CB	FM-725 725C	JR1012 743/744/746/305			
502-405-000	CB	Sewist 725S/721/709 507F/507G	Sewist 625E/525S/521/509 507A/507B/507BE			
503-801-003	CB	6019QC/6125QC 503				
502-403-008	NP	M30A 805A				
489-710-007	NP	MC7700QC (Standard Accessory) 858A	MC8200QCP/ MC8200QC 858F	MC8900QCP (Standard Accessory) 858G		
491-701-013	CB	DC4030 807F	DC2019/DC2010 843S2	8077/Magnolia7330 843W		
491-701-091	CB	MC4900 847B	MC5200 844C			
499-701-006	CB	HD9P/1600P 767				
808-401-003	NP	3160QDC/2160DC 2030DC 808A/D/F	4120QDC/4300QDC/5300QDC 5270QDC/DC7100/7060/6030 5060QDC (Standard Accessory) 809A/AS/AU/N/J2/J3/F	MOD100/50/30 811	M200QDC/M100QDC M50QDC 812	780DC/740DC 814
808-428-006	CB	3160QDC/2160DC 2030DC 808A/D/F	4120QDC/4300QDC/5300QDC 5270QDC/DC7100/7060/6030 5060QDC 809A/AS/AU/N/J2/J3/F	MOD100/50/30 811	M200QDC/M100QDC M50QDC 812	780DC/740DC 814
863-414-000	CB	MC9900/MC9850 861	Skyline S9 862SA	Skyline S7/S6/S5/S3 863AU/863F/863A/863AL		
846-401-104	CB	MC6700P (Standard Accessory) 866	MC6650 866	MC6600P 846F		
865-806-009	NP	MC9450QCP (Standard Accessory) 865C	MC9400QCP (Standard Accessory) 865A			
868-404-013	CB	CM17 868	CM7P (Standard Accessory) 867			
864-408-004	CB	MC500E/MC450E/ MC400E 864AU/A/AL				
864-408-015	CB	MC550E/MC500E MC450E/MC400E 864F/AU/A/AL				
770-814-003	CB	MB-4S/MB-4 770	MB-7 771			
202-438-106	CB	8002D 792W				
795-812-307	CB	CoverPro 2000CPX 796D	CoverPro 3000P 778			

SPOOL STAND



The two/five pin spool stand attaches easily to the back side of your machine. When using multiple colors of embroidery thread it makes for trouble-free embroidery, as it allows you to set out your colors as you sew.

Part Number	Package	Number of spool	Thread Guide	Compatible Model
859-429-005	CB	For Two Spools	Round X 1	MC15000/MC14000/MC12000/MC9900/MC9850/MC9450/MC9400/Skyline S9/S7/S6/S5/S3
858-402-009	CB		Square X 1	MC8900/MC8200/MC7700
859-429-016	CB		Round X 1 Square X 1	MC15000/MC14000/MC12000/MC9900/MC9850/MC9450/MC9400/MC8900/MC8200/MC7700/MC550E/MC500E/MC450E/MC400E/Skyline S9/S7/S6/S5/S3

Part Number	Package	Number of spool	Thread Guide	Compatible Model
852-406-005	CB	For Five Spools	Square x 1	MC350E
832-420-014	CB		Square x 1	MC10001/MC10000/MC9700/MC9500/MC9000/MC300E
860-406-000	CB		Square x 1	MC11000/MC200E
859-430-009	CB		Round x1	MC15000/MC14000/MC12000/MC9900/MC9850/MC9450/MC9400/MC7700/MC550E/500E/450E/400E/Skyline S9/S7/S6/S5/S3
868-405-014	CB		Not Available	CM17

I N D E X

JANOME QUALITY

ACUFEED 1/4 INCH SEAM FOOT AND NEEDLE PLATE	10
ACUFEED 1/4INCH SEAM FOOT	10
ACUFEED DITCH QUILTING FOOT(Dual feed ditch quilting foot)	10
ACUFEED FLEX PROFESSIONAL GRADE FOOT	12
ACUFEED FOOT WITH FOOT HOLDER(Dual feed foot with Dual feed holder)	11
ACUFEED OPEN TOE FOOT(Dual feed open toe foot)	10
ACUFEED QUILT PIECING FOOT(Dual feed quilt piecing foot)	10
ACUFEED STRAIGHT STITCH FOOT	10
ACUFEED ZIPPER FOOT(Dual feed zipper foot)	11

GENERAL SEWING MACHINES

1/4 INCH RULER FOOT	30
1/4 INCH SEAM FOOT	27
1/4 INCH SEAM FOOT (WITHOUT GUIDE)	27
3-WAY CORDING FOOT	25
ACUFEED 1/4 INCH SEAM FOOT AND NEEDLE PLATE	27
ACUFEED DITCH QUILTING FOOT	27
ACUFEED OPEN TOE FOOT	18
ACUFEED QUILT PIECING FOOT	27
ACUFEED STRAIGHT STITCH FOOT	14
ACUFEED ZIPPER FOOT	21
APPLIQUE FOOT	14
BEADING FOOT	25
BI-LEVEL FOOT	19
BIAS TAPE ATTACHMENT	22
BINDER FOOT	18
BLIND HEM ATTACHMENT	22
BLIND HEM FOOT	20
BOBBIN HOLDER FOR FREE QUILTING AND HAND-LOOK STITCHING	33
BOBBIN HOLDER(high tension for embroidery use)	36
BORDER GUIDE FOOT	33
BUTTON SEWING FOOT	26
BUTTONHOLE STABILIZER PLATE	34
CIRCULAR ATTACHMENT	35
CLEAR VIEW 1/4 INCH SEAM FOOT	27
CLEAR VIEW QUILTING FOOT AND GUIDE SET	28
CONCEAL® ZIPPER FOOT	21
CONVERTIBLE EVEN FEED FOOT SET	29
CONVERTIBLE FREE MOTION QUILTING FOOT SET	31
CUSTOM CRAFTED ZIGZAG FOOT	18
DARNING FOOT	15
DITCH QUILTING FOOT	27
DITCH QUILTING GUIDE AND ADJUSTABLE QUILTING GUIDE SET	29
EDGE GUIDE FOOT	35
EVEN FEED FOOT WITH QUILTING GUIDE (OPEN TOE)	29
EVEN FEED FOOT WITH QUILTING GUIDE (REGULAR)	29
FLOWER STITCHER	36
FREE MOTION COUCHING FOOT SET	33
GATHERING FOOT	17
HD ROLLER FOOT	16
HEMMER FEET SET	22
LAP-SEAM FOOT	19
LARGE BUTTONHOLE FOOT AND STABILIZER PLATE	34
LONG QUILTING GUIDE BAR SET	29
OVERCASTING FOOT	20

OVEREDGE FOOT	20
PINTUCKING CORD GUIDES	24
PINTUCKING FEET	24
PIPING FOOT	23
PIPING FOOT (NARROW)	23
QUILT BINDER SET	36
RIBBON SEWING GUIDE	34
RIBBON/SEQUIN FOOT	26
ROLLED HEM FOOT	22
ROLLER FOOT	15
ROTARY EVEN FOOT	22
ROUND HEMMER FOOT	22
RUFFLER	25
SATIN STITCH FOOT	17
SLIDING BUTTONHOLE FOOT	26
SLIDING GUIDE FOOT	15
STRAIGHT STITCH FOOT	14
TAPING GUIDE FOOT	19
TRANSPARENT BUTTONHOLE FOOT	26
ULTRA GLIDE FOOT	16
ULTRA GLIDE NEEDLE PLATE	16
WIDE ROLLED HEM ATTACHMENTS	22
ZIPPER FOOT	21

OVERLOCKERS

BEADING FOOT	39
BLIND STITCH FOOT	38
CLOTH GUIDE	40
CORDING FOOT(A)	39
CORDING FOOT (B)	37
ELASTIC GATHERING ATTACHMENT	38
GATHERING ATTACHMENT	40
PIPING FEET	40
TAPING FOOT WITH REEL	38
WASTE CHIP BOX	39

COVER STITCH MACHINES

ADJUSTABLE SEAM GUIDE	42
BIAS TAPE GUIDE AND BELT LOOP FOLDER	44
BINDER FOOT WITH GUIDE	44
CENTER GUIDE FOOT	42
CLEAR VIEW COVER STITCH FOOT	41
ELASTIC GATHERING ATTACHMENT	42
HEM GUIDE	41
TAPE BINDER	43
TAPE BINDER AND BINDER FOOT WITH GUIDE	44
TAPE STAND	44

PROFESSIONAL OVERLOCK

AND COVER STITCH

MACHINES

BEADING FOOT	46
BELT LOOP FOOT	48
BIAS TAPE FOOT	48
BLIND STITCH FOOT	46
COVER HEM FOOT, LACE ATTACHEMNT, HEM & WRAPPED EDGE GUIDES	47
GATHERING FOOT	45

HIGH SPEED MACHINES

1/4 INCH SEAM FOOT	51
1/4 INCH RULER FOOT SET	55
ADJUSTABLE SEAM GUIDE	54

ADJUSTABLE ZIPPER FOOT	53
CONCEAL® ZIPPER FOOT	53
CONVERTIBLE FREE MOTION QUILTING FOOT SET	54
DARNING FOOT WITH DARNING PLATE	52
DITCH QUILTING FOOT	51
EVEN FEED FOOT	52
FREE MOTION FRAME QUILTING FEET SET	55
HD ROLLER FOOT	49
SPECIALIZED STRAIGHT STITCH FEET	50
TAPING FOOT	53
ULTRA GLIDE FOOT	49
VELVET FOOT	50

NEEDLE PUNCHING

FINE NEEDLE REFILL	56
FIVE NEEDLE (FIXED) UNIT	56
NEEDLE UNIT WITH PRESSER FOOT INCLUDING FIVE NEEDLE (REPLACEABLE) UNIT	56
SINGLE NEEDLE (FIXED) UNIT	56
STANDARD NEEDLE REFILL	56

MISC. ACCESSORIES

ASSORTED SEWING NEEDLES	59
BLUE BOBBIN	65
BLUE TIP NEEDLES	59
BOBBIN CASES	65
BOBBINS	65
BRUSH-OUT EMBROIDERY KIT	64
CLOTHSETTER/CLOTHSETTER TABLE	62
CUTWORK NEEDLE HOLDER	59
CUTWORK NEEDLE SET	59
EMBROIDERY COUCHING FOOT SET	64
EMBROIDERY HOOP	70
EXTRA WIDE TABLE	71
FM725 CHANGEABLE NEEDLE UNIT	60
FM725 FIXED FIVE FELTING NEEDLE UNIT	60
FM725 FIXED SINGLE FELTING NEEDLE UNIT	60
FM725 NEEDLE REFILLS	60
INSERT PLATE A	63
INSERT PLATE B	63
INSERT PLATE C	63
INSERT PLATE D	63
INSERT PLATE E	63
INSERT PLATE F	63
INSERT PLATE G	63
INSERT PLATE H	63
LARGE EMBROIDERY DESIGN COLLECTION	64
LARGE FOOT CONTROLLER	66
NET	67
OPTIC MAGNIFIER	69
PIN CUSION	67
PINK BOBBIN	65
PROTECTIVE SHEET	66
PURPLE TIP NEEDLES	59
RED TIP NEEDLES	59
REMOTE THREAD CUTTING SWITCH UNIT	66
SEWING MAT	67
SIDE TABLE STAND UNIT	64
SKYLINE ACCESSORY CASE	69
SPOOL HOLDER (SPECIAL)	66
SPOOL STAND	72
STRAIGHT STITCH NEEDLE PLATE	68
UNIVERSAL TABLE STAND	63
UNIVERSAL TABLE STAND FOR CM17 & CM7P	63

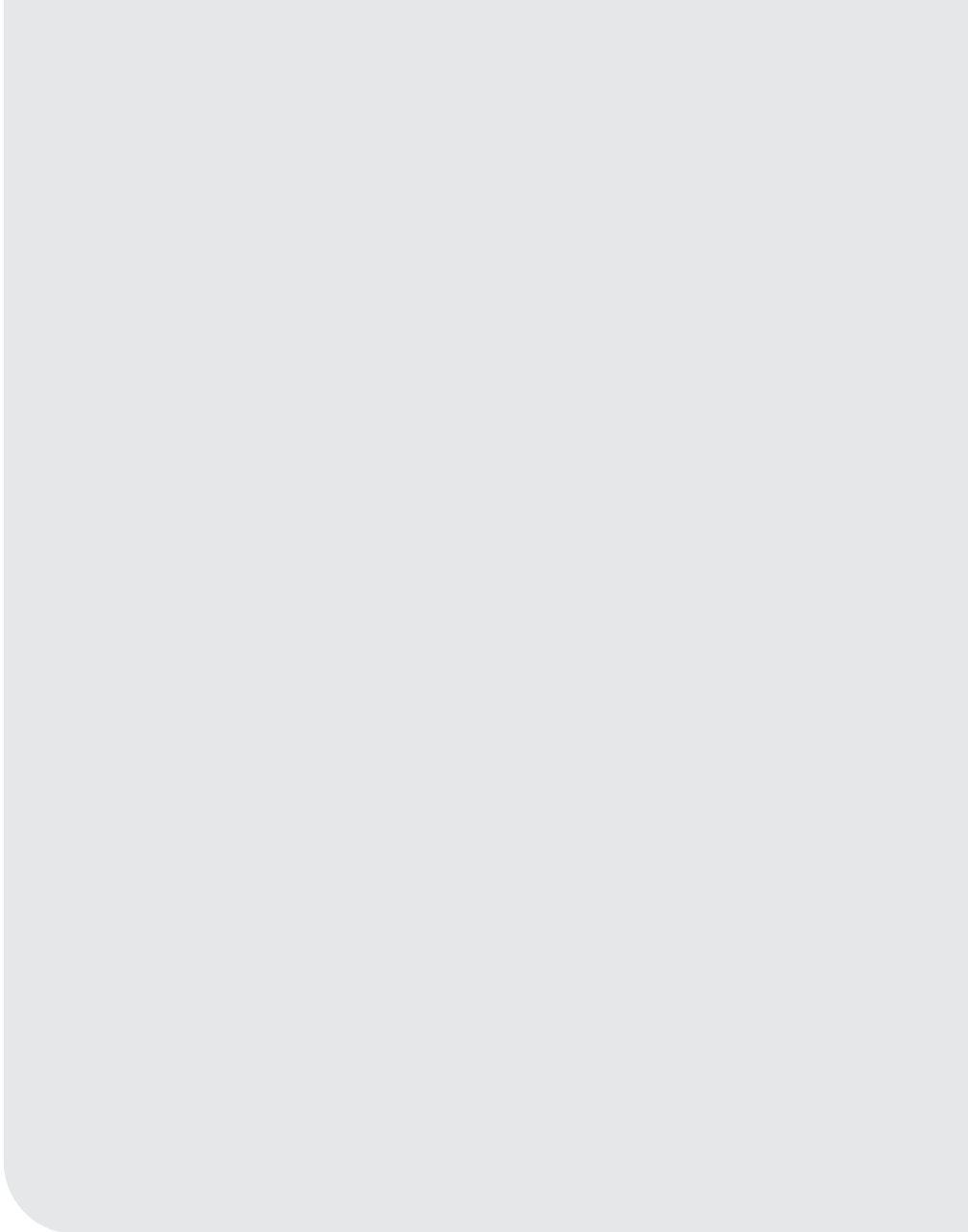

JANOME

JANOME Corporation

YOU 2023.07

