

# JANOME

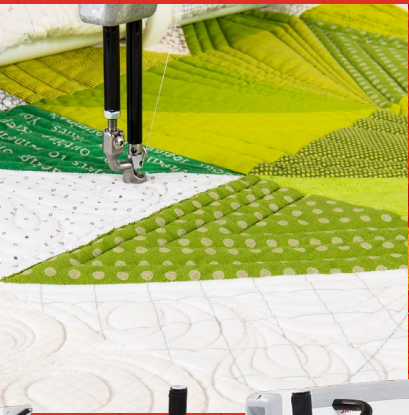

—LONG ARM—

## Reference Guide

UPDATED JANUARY 2023

WWW.JANOME.CA

# Long Arm Quilting Machines



Shown with optional  
Pro-Stitcher, rear handlebar  
kit and casters

## Quilt Maker Pro 20

Includes 12' Frame and Bobbin Winder

### FEATURES

- 20" Machine arm
- Speed up to 2,500 stitches per minute
- Two modes of Stitch Regulation: Precision and Cruise
- Precise Stitch Regulation from 5 to 24 SPI
- Manual speed mode with 3 customizable presets
- 5 Basting stitch options (1/4, 1/2", 1", 2", 4")
- Built-in telescoping thread stand
- Height adjustable front handlebar with digital touchscreen display for micro quilting
- Included quick change sewing feet: Closed toe foot (installed) and open toe foot
- Front and rear power switches
- LED light ring mounted above the needle
- LED lighting mounted over throat and bobbin area
- High-speed rotary hook with large-capacity M-class bobbin
- Stitch counters
- Needle stop position control
- Bobbin use estimator with low-bobbin alarm
- Quilting alarm and project timer
- Built-in diagnostics
- On screen hand wheel to cycle the needle up and down

### QUILT FRAME

- Unique quilt top bar configuration
- 12' ProFrame; 4', 8', 12' increments
- Adjustable legs for easy height transition
- Leveling feet to adjust to all floor surfaces
- Hand wheel and bearings for easy turning
- Constructed of high-quality steel
- Specialty clamps with elastic style bungee cords to maintain even tension on quilt
- Snap-in poles
- 3 Canvas leaders

### INCLUDED ACCESSORIES

- Closed toe foot and open toe foot
- Accessory pack: 4 extra bobbins, 20 needles, sample thread, hook oil, cleaning brush and bobbin tension screwdriver

### OPTIONAL ACCESSORIES

- 20" Machine Ruler Base
- 2' ProFrame Replacement Section for 12' frame
- Rear Handlebar Kit
- Hand Wheel Kit
- Tool Tray
- ProStitcher20
- Pro Highlight
- Fabric Hammock
- Horizontal Spool Pin

- Set of 8 Casters (for ProFrame 10' or 12')
- Drawer 4'
- Bobbins (8 Pack)
- Bobbin Case
- Couching Feet Set
- Glide 2 Foot
- EZ Ruler Foot
- Square Feet Set
- Echo Feet Set
- Electromagnetic Channel Locks
- Channel Locks
- Needles (Pack of 10), Size 18, Sharp
- Needles (Pack of 10), Size 16, Sharp
- Needles (Pack of 10), Size 14, Sharp
- Ruler Circle Set
- Ruler Ditch
- Ruler Half Circle Set
- Ruler Mini Scallop
- Ruler Multi Clamshell
- Ruler Oval Set C
- Ruler Straight Rulers 3 x 12"
- Ruler Swag Templates 4"
- Ruler Wave F

# Long Arm Quilting Machines



Shown with optional 8' black table top kit

## Quilt Maker 15

Includes 8' Lite Frame and Bobbin Winder

### FEATURES

- 15" Throat space
- 1.44" High-resolution, full-color display
- 1,800 Stitches per minute
- 4-18 Stitches per inch
- Choose from Cruise or Precision stitch regulation or Manual Mode
- High-speed rotary hook with large capacity M-class bobbin
- Built-in LED lighting to illuminate quilting space
- USB port for easy software updates
- Front-mounted LCD monitor with integrated USB port
- LED light ring around the needle bar and ergonomic front handlebars.
- Quilting alarm, project timer and built-in diagnostics
- Stitch counter
- Needle up/down function
- Compatible with Pro-Stitcher Lite 15

### INCLUDED ACCESSORIES

- Closed toe foot and open toe foot
- 5 Bobbins
- 20 Needles
- Bobbin Case
- ProFrame 8

### OPTIONAL ACCESSORIES

- 15" Machine Ruler Base
- ProStitcher Lite for QM15
- QM15 Rear Handlebar and Display Kit
- 2' Extension for 8' Lite Frame
- Black table top kit for 8' Lite Frame
- Mini Casters (4 pack)
- Pro Highlight
- Bobbins (8 Pack)
- Bobbin Case- Channel Locks
- Tool Tray
- Pinpoint Needle Laser
- Couching Feet
- Echo Feet Set
- EZ Ruler Foot
- Glide 2 Foot

- Square Feet Set
- Needles (Pack of 10), Size 18, Sharp
- Needles (Pack of 10), Size 16, Sharp
- Needles (Pack of 10), Size 14, Sharp
- Ruler Circle Set
- Ruler Ditch
- Ruler Half Circle Set
- Ruler Mini Scallop
- Ruler Multi Clamshell
- Ruler Oval Set C
- Ruler Straight Rulers 3" x 12"
- Ruler Swag Templates 4"
- Ruler Wave F

# Long Arm Quilting Machines



## Versa - QMPro 18

Includes Bobbin Winder

### FEATURES

- 18" Throat space and 8" throat height  
(Four times the quilting space of the average home sewing machine)
- Easy setup and assembly
- Paired with the exclusive Versa Table with built-in Versa Stitch Regulation
- Adjustable table height: 25.5" to 39.5"
- Up to 2,200 stitches per minute
- 4 to 22 Stitches per inch
- Two modes of stitch regulation: Precision or Cruise
- Adjustable high-resolution color touch screen
- Needle-stop position control
- Foot pedal
- Easy needle change
- Low bobbin estimator and alarm
- Quilting alarm and project timer
- Five basting stitch options
- Presets for saving favorite manual mode stitching options
- Stitch counter
- Built-in diagnostics
- Easy USB machine and software updates

### QUILT TABLE

- 31.5" x 36" full table surface
- Adjustable legs for easy height transition: sit or stand with preference
- 14 Different available height positions
- Leveling feet to adjust to all floor surfaces
- Constructed of high quality steel
- Smooth top for easy free motion quilting
- Constructed to conceal all cords behind and underneath table

### INCLUDED ACCESSORIES

- Closed toe foot and open toe foot
- Accessory pack: 4 extra bobbins, 20 needles, sample thread, hook oil, cleaning brush and bobbin tension screwdriver

### OPTIONAL ACCESSORIES

- Pro Highlight
- Horizontal Spool Pin
- 18 x 32" Table Extension
- Mini Casters (4)
- Bobbins (8 Pack)
- Bobbin Case

- Couching Feet
- Echo Feet Set
- EZ Ruler Foot
- Glide 2 Foot
- Square Feet Set
- Needles (Pack of 10), Size 18, Sharp
- Needles (Pack of 10), Size 16, Sharp
- Needles (Pack of 10), Size 14, Sharp
- Ruler Circle Set
- Ruler Ditch
- Ruler Half Circle Set
- Ruler Mini Scallop
- Ruler Multi Clamshell
- Ruler Oval Set C
- Ruler Straight Rulers 3" x 12"
- Ruler Swag Templates 4"
- Ruler Wave F

# Long Arm Computerized Automation

## Pro-Stitcher20

Compatible with QMPro20

### FEATURES

- 12-inch color touchscreen computer mounted on the stitch-regulated quilting machine
- Operate entire system from one screen
- Includes 800+ designs, including a designer showcase of motifs from your favorite designers
- Switch between computer-guided and free-motion quilting at the touch of a button
- Resize, Rotate and Repeat designs to fit specific areas
- Skew or Align designs to fit any area with three or more points
- Move designs into position by simply moving your finger across the screen
- Stretch and resize a design using on-screen handles
- Define and Fill an area with a design, using 2-corner (rectangles) or multi-point (any shape)
- Save and move areas
- Two-Point Rotation for border designs and fitting odd angles
- Precisely reposition designs using the Center Point, Start Point, End Point, any corner of the design area, or any point within the design
- Crop inside or outside of your design to fit your quilt, with the option to close the jumps or leave them open
- Create new start/stop points
- Place designs into borders and other odd-shaped spaces
- Customizable speed and stitches-per-inch
- Micro Tie-Off function
- Ability to read most .hqf, .hqv and .qli digital quilt patterns
- Seamless integration with Pro-Stitcher Designer™ for designing and adjusting your own patterns at the longarm machine or on your computer (included software)
- Mark and record multiple points for accurate stitch-in-the-ditch quilting
- On-screen Grid and Ruler to measure designs or area on quilt
- Reorder designs for stitching
- Horizontal and vertical channel lock
- Help menus always accessible

### EASY-TO-USE QUILTING OPTIONS FOR ACHIEVING A CUSTOM LOOK

- Quilt edge-to-edge or block patterns with confidence in a few simple steps
- Simple and accurate stitch-in-the-ditch
- EZ Record: record unique digital designs for future use (newly created designs can be saved on a USB or hard drive of the Pro-Stitcher to be resized, repositioned or edited)
- Built-in ruler tool for measuring in any direction
- Switch from computerized quilting to free-motion quilting in seconds
- Uses only designs in .hqv, .hqf, and .qli formats

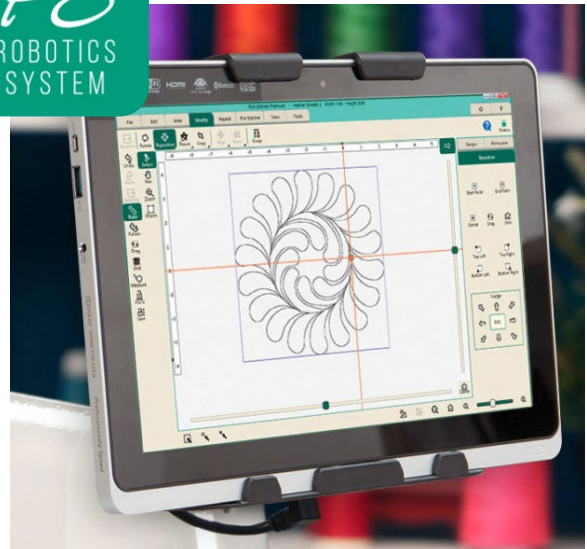

PART: QMPSTITCHER-20

### ADVANCED TECHNOLOGY FOR EASE OF USE

- Silent, integrated motor-control systems with fluid motion control
- No additional computer needed to run the Pro-Stitcher
- Separate PC connected to the Internet required for downloading new designs and software updates
- USB port to easily upload digital patterns to Pro-Stitcher
- Draw your own quilting motifs from scratch
- Fill shapes with cross-hatching, wave fills, stippling, and more
- Use fills around a design
- Turn shapes into appliqué designs with a mouse click

# Long Arm Computerized Automation

## Pro-Stitcher LITE

Compatible with QM15

### EASY-TO-USE QUILTING OPTIONS

- Quilt edge-to-edge or block patterns with confidence
- Simple and accurate stitch-in-the-ditch
- Built-in ruler tool for measuring in any direction
- Switch seamlessly between computer-guided and free-motion quilting
- Use nearly any digital pattern (.hqv, .hqf, and .qli formats)

### - KEY FEATURES:

- 11-inch color touchscreen computer mounted on the stitch-regulated quilting machine
- Includes 250+ pre-loaded designs
- On-screen Grid and Ruler to measure designs or area on the quilt
- Position designs by simply moving your finger across the screen
- Resize, Rotate and Repeat designs to fit specific areas
- Skew or Align designs to fit any area with three or more points
- Adjust designs using on-screen handles
- Define and Fill an area with a design, using 2-corner (rectangles) or multi-point (any shape)
- Variable speed and stitches-per-inch settings
- Horizontal and vertical channel lock
- Compatible with Pro-Stitcher Designer™ software
- Reads most .hqf, .hqv, and .qli digital quilt patterns
- Includes 8' black top table kit for 8 foot lite frame

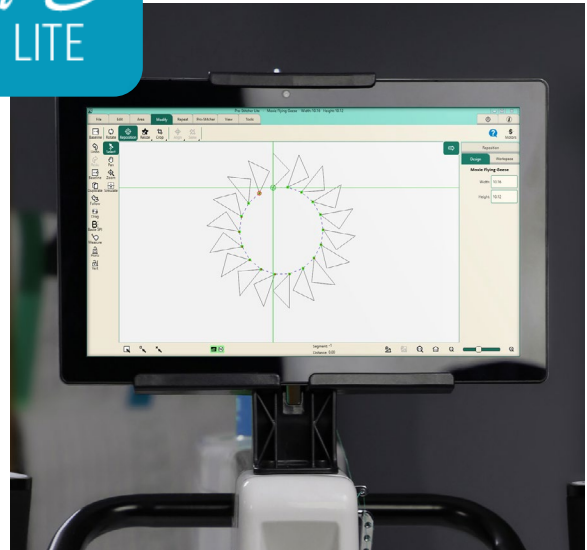

PART: QM50001-JA

# Long Arm Optional Accessories



## EZ Ruler Foot

The EZ Ruler Foot has a taller profile than the standard ruler foot and provides additional stability when using rulers. The EZ Ruler Foot is also useful when quilting with high loft batting or multiple layers of batting.

Long arm compatible, requires an interchangeable foot mount.



## Glide 2 Foot

The Glide foot is a bowl shaped foot perfect for using with rulers and for quilting on an uneven fabric such as heavily textured or appliqued quilt tops.

Long arm compatible, requires an interchangeable foot mount.



## Echo Foot Set

The Echo Foot Set contains a set of three acrylic feet with a ring that extends the width of the hopping foot. The feet provide a fixed interval to use when echo quilting around a motif or when using rulers. The Echo Feet provide a 3/8-inch interval, a 1/2-inch interval, and a 3/4-inch interval.

Long arm compatible, requires an interchangeable foot mount.



## Couching Foot Set

Couching is a decorative thread work technique in which threads, yarns, or other fibers are laid across the quilt and fastened in place by the machine's quilting thread. The three sizes of couching feet in this kit enable you to couch a wide variety of threads, yarns, ribbons, and other fibers to add a special touch to your quilts. The Couching Kit includes three sizes of interchangeable couching feet: 1.5 mm, 2 mm and 3 mm.

Long arm compatible, requires an interchangeable foot mount.



## Square Foot

Square Feet are designed to aid in achieving straight seams while piecing on your quilting frame. These feet can be used as a guide for consistent seam allowances of 1/4 inch and 1/2 inch. The 1/4-inch Square Foot is great for cotton fabrics, the 1/2-inch Square Foot is best for cuddle type fabric and high loft batting.

Long arm compatible, requires an interchangeable foot mount.

\*Standard Accessory, comes with the machine or frame.

# Long Arm Optional Accessories



## Bobbin Case

Bobbin tension for Quilt Maker long arm models is set in the bobbin case. If you use a few standard varieties of bobbin threads, it is handy to set the tension on each case to match that thread types you use most and speed up the creative process.

COMPATIBLE | VERSA QM15 QMP20



## EZ-Wind Bobbins

Set of 8 large-capacity M-class slotted aluminum bobbins. Keep bobbins wound with your favorite thread.

COMPATIBLE | VERSA QM15 QMP20



## Horizontal Spool Pin

Delicate threads and small spools may need to feed into your thread guides differently than standard cottons and polyesters. In these cases, the best results may come from using a Horizontal Spool Pin that mounts to the threaded hole at the front of the machine.

COMPATIBLE | VERSA QMP20



## Ruler Base

Made from thick durable acrylic, the ruler base accessory extends from the base of the long arm to provide a firm stable surface when using rulers, guides and templates.

QMP20 - Ruler Base | PART: HG00458-JA

QM15 - Ruler Base | PART: HG00446-JA

\*Standard Accessory, comes with the machine or frame.



# Long Arm Optional Accessories

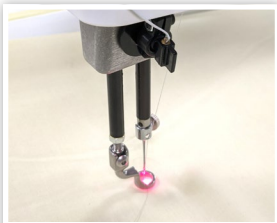

PART: HG01005-JA

## Pinpoint Needle Laser

Pinpoint Needle Laser provides a guide for accurate needle placement and is adjustable for precise alignment with the machine needle. Compatible with most longarm machines with USB ports at the front of the machine. If no port is available at the front of the machine, this accessory can also be installed with the addition of a USB 2.0 wall charger and USB 2.0 Type-A male to female extender cable (not included).

COMPATIBLE | VERSA QM15 QMP20\*



## Needles for Long Arms

Our Groz-Beckert Longarm Needles are specifically made for multi-directional use, which is exactly what longarm machines need. Multi-directional design means more accurate stitching while moving the machine in any direction. Extra strength allows maximum flexibility and bending. The deep scarf prevents skipped stitches, less puckering, and less thread breakage. (The 'MR' style designates the needle as Multi-directional, also called a Specialty Application Needle or SAN).

Groz-Beckert Needles 110/18R Black (10/PK), Sharp | PART: QM00267

Groz-Beckert Needles 100/16R (10/pk), Sharp | PART: QM00246

Groz-Beckert Needles 90/14R (10pk), Sharp | PART: QM00240



## Rear Handlebar and Display Kit

Rear handlebars functions mirror the front handlebars, making it easy to move from the front to the back with consistency. A bright interactive LCD screen displays user settings. Use pantographs for edge-to-edge quilting in conjunction with the included laser light.

QM20 - Rear Handlebar and Display Kit | PART: QM29258

QM15 - Rear Handlebar and Display Kit | PART: QM29415-JA



PART: HG00707

## Electromagnetic Channel Lock (EMCL)

Electromagnetic Channel locks integrate into the Quilt Maker Pro Models using a control box and magnets that lock onto thin plates of steel running the length of the frame and also the carriage. This enables quilters to stitch perfectly straight horizontal and vertical lines by manually using the attached control box. This will not work for the QM15.

COMPATIBLE | QMP20

\*Standard Accessory, comes with the machine or frame.

# Long Arm Optional Accessories

## Rulers for Long Arm Quilting

Janome long arm compatible rulers make your quilting experience even easier! These 1/4 inch clear acrylic rulers have been hand selected and make the perfect addition to your long arm accessory collection. The durable rulers and ruler sets are easy to grip with grids and alignment lines for accurate stitch placement.

For use with all Quilt Maker models and high shank sewing machines (requires a compatible 1/4 inch ruler foot).

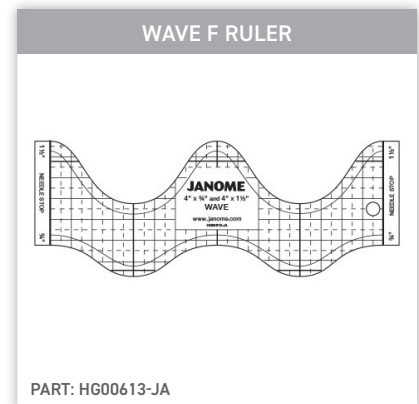
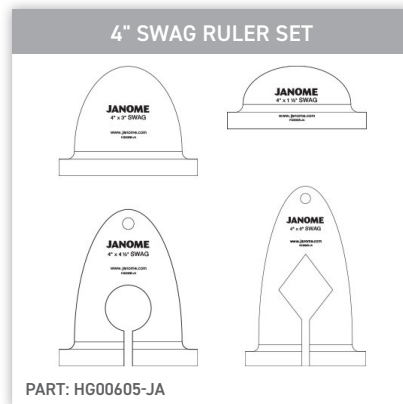
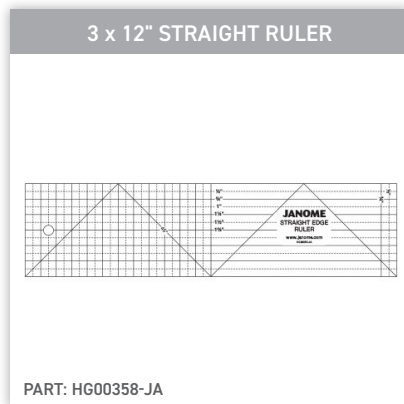
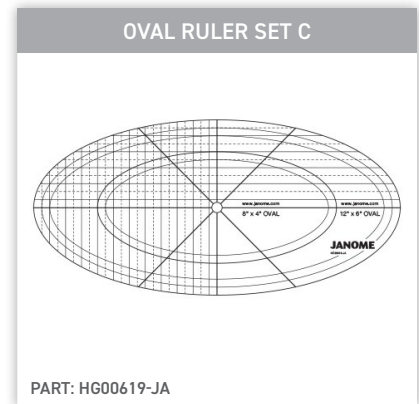
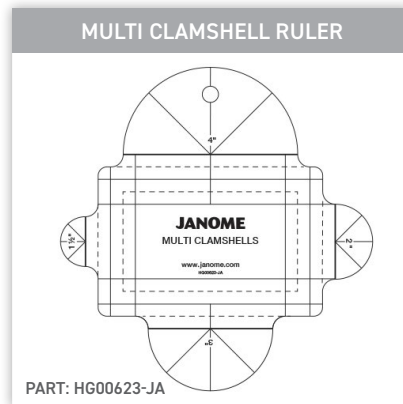
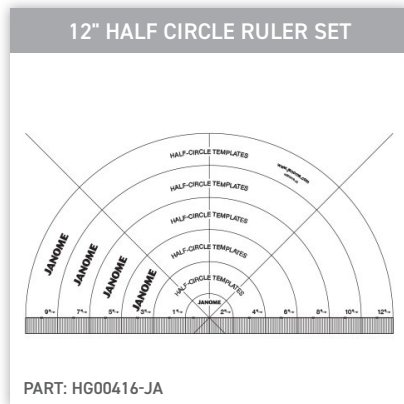
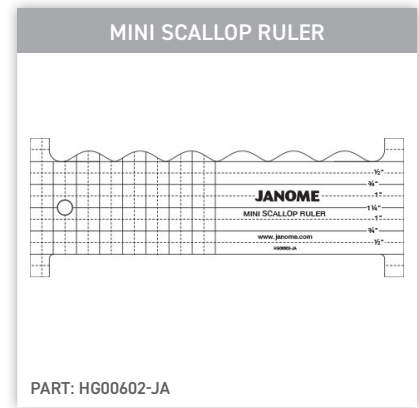
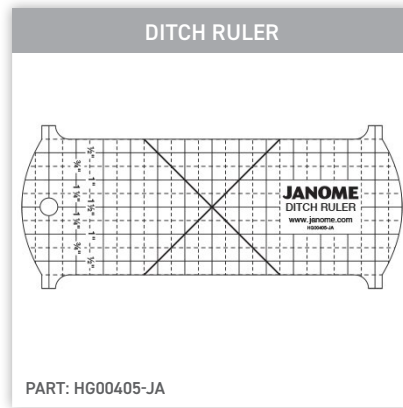
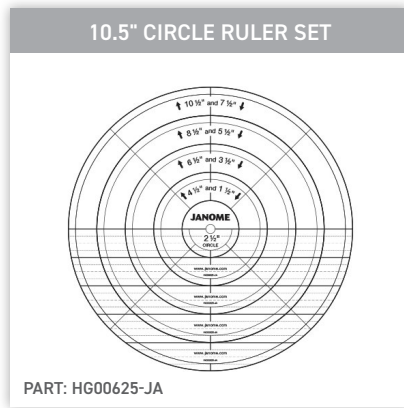

\*Standard Accessory, comes with the machine or frame.

# Long Arm Frames and Accessories



## 10' ProFrame

PART: PROFRAME10

The 10' ProFrame is compatible with Quilt Maker Pro stand-up longarm quilting machines. Made of high-quality steel, 10' ProFrame is a robust professional-grade combination table and frame system for the home or professional studio. Not compatible with QM15.

### Features:

Zinc-plated hardware resists corrosion, Pole cradles provide accessibility for loading quilt batting, Height-adjustable legs with self-leveling feet accommodate a variety of floor surfaces, Three canvas leaders with Velcro attachment, Bungee-style elastic side tensioning system, Built-in hand wheel, snap-in poles, and smooth-rolling bearings make advancing the quilt a simple task, Batting storage pole keeps batting rolls off the floor, Continuous track support ensures a bump-free quilting experience

Optional 4 foot drawer, hand wheel kit, hammock and casters available.

Shown with optional casters

COMPATIBLE |

QMP20

## 8' Lite Frame

Height-adjustable table, choose from two different loading modes: High (for a standard "quilt in the trough" experience, useful for beginners) or Low (for better visibility when using rulers). Made of high-quality, powder-coated steel for a firm base for longarm quilting. Ratcheted-pole ends hold quilt firmly for perfect stitching. Includes two bungee side clamps and 7.5 leader included.

Optional 2-Foot extension kit, casters and table top kit available.



COMPATIBLE |

QM15\*

\*Standard Accessory, comes with the machine or frame.

# Long Arm Frames and Accessories

---



## 12' ProFrame

PART: PROFRAME12

The 12' ProFrame is compatible with Quilt Maker Pro stand-up longarm quilting machines. Made of high-quality steel, 12' ProFrame is a robust, professional-grade combination table and frame system for the home or professional studio. Not compatible with QM15.

### Features:

Zinc-plated hardware resists corrosion, Pole cradles provide accessibility for loading quilt batting, Height-adjustable legs with self-leveling feet accommodate a variety of floor surfaces, Three canvas leaders with Velcro attachment, Bungee-style elastic side tensioning system, Built-in hand wheel, snap-in poles, and smooth-rolling bearings make advancing the quilt a simple task, Batting storage pole keeps batting rolls off the floor, Continuous track support ensures a bump-free quilting experience

Optional 4 foot drawer, hand wheel kit, hammock and casters available.

COMPATIBLE |

QMP20\*

\*Standard Accessory, comes with the machine or frame.

# Long Arm Frames and Accessories

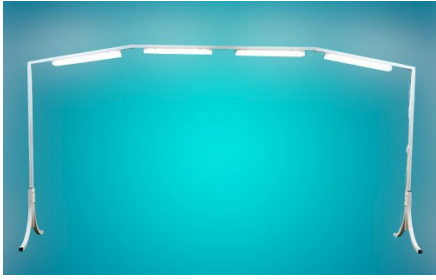

## PRO HIGHLIGHT 10'

PART: HG01201-10

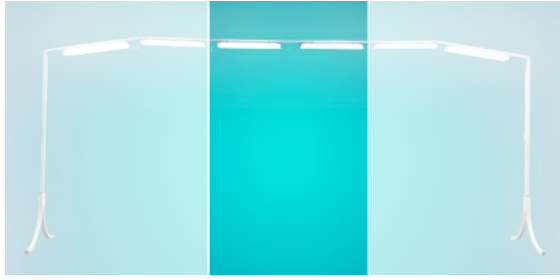

## PRO HIGHLIGHT 2' EXTENSION

(shown with Pro Highlight 10')

PART: HG01201-02

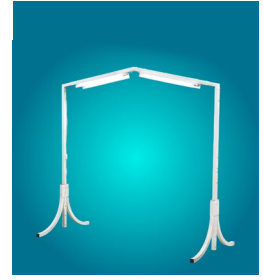

## PRO HIGHLIGHT 5'

PART: HG01201-05

### Pro Highlight

Seeing is believing. The Pro Highlight system is a simple light bar that provides the brightest LED lighting for any space. It's easy to assemble with a simple on/off switch and is height adjustable. This is the ultimate lighting solution for sewing studios, workshops, garages and craft rooms. Optional Pro Highlight 2' Extension accessory extends the Pro Highlight 10' to fit over 12 ft frames.

- Energy-efficient, low-wattage (low-heat) LED lights
- 50,000 hour life with 1,800 lumens per two-foot section
- Adjustable shades direct light exactly where it's needed
- Adjustable height (68 to 80 inches)
- High-quality steel provides a solid free-standing foundation
- Zinc-plated hardware resists corrosion

COMPATIBLE | V 8 10 12



PART: QT09014-JA

### Versa Table Wing Extension

Add up to 36 inches of extra surface space to the Versa stationary longarm table with the 18 inch Versa table wing extension. Easy to install, these extensions pop up when needed and neatly fold down when not in use.

COMPATIBLE | V



PART: HG00271

### Tool Tray

Comes with 16 dividers to divide and organize tools or quilting supplies. Measures 8.75" x 32.25" x 3.25".

COMPATIBLE | V 8 10 12

\*Standard Accessory, comes with the machine or frame.

# Long Arm Frames and Accessories



## 11' Leader Set

Ideal for 12 foot frames. Three leaders per set: (1) 11 feet x 27" Take-up leader and (2) 11 feet x 17" Leaders. Leaders are firmly woven, sturdy twill cotton fabric with hemmed edges and extra-wide Velcro tape to attach leaders to the Quilt Maker frame system. May be cut for a custom fit.

COMPATIBLE | 8 10 12\*



## 9.5' Leader Set

Ideal for 10 foot frames. Three leaders per set: (1) 9.5 feet x 27" Take-up leader and (2) 9.5 feet x 17" Leaders. Leaders are firmly woven, sturdy twill cotton fabric with hemmed edges and extra-wide Velcro tape to attach leaders to the Quilt Maker frame system. May be cut for a custom fit.

COMPATIBLE | 8 10\* 12



## Channel Locks

Channel locks prevents a long arm Quilt Maker model from moving along a certain axis. Can be used on the horizontal carriage wheels when making straight vertical lines or on the vertical carriage wheels for making straight horizontal lines. This is great for ditch quilting block outlines and borders when a long straight stitch is necessary.

COMPATIBLE | 8 10 12

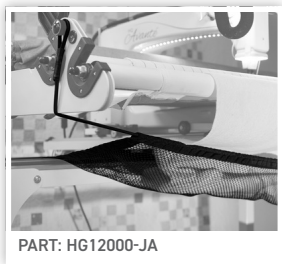

## Fabric Hammock

Conveniently store and protect quilt batting while quilting. Hardware is included to permanently install your hammock on your Quilt Maker longarm ProFrame. Compatible with 10' and 12' ProFrames.

COMPATIBLE | 10 12



## 8' Table Black Top kit

Creates a table surface for pantographs. Includes two 4-foot black table top pieces. Compatible with 8' Lite Frame only.

COMPATIBLE | 8

\*Standard Accessory, comes with the machine or frame.

# Long Arm Frames and Accessories



## Caster Set (8)

Set of 8 Casters - Replace leveling feet with easy rolling casters! Locking casters include leveling feature. Sturdy design allows for easy rolling even when frame is loaded. Compatible with 5, 10 and 12 foot frames.

COMPATIBLE | 10 12



## Mini Caster Set (4)

Set of 4 Casters. Mini locking casters provide convenient portability for the Versa stationary table and 8' Lite frame. Maximum weight per caster 100lbs. Not compatible with 5, 10 and 12 foot frames.

COMPATIBLE | V 8



## Hand Wheel Kit

The Hand Wheel Kit contains everything you need to add a hand wheel to the backing pole. When used in combination with the hand wheel on the take-up pole, it becomes easier to advance the quilt on the frame.

COMPATIBLE | 10 12



## 2' Frame Extension

This 2' frame extension converts the QM15 standard 8' Lite Frame into a 10 foot frame. Included in the package is all the hardware needed to lengthen the frame's table bed: 1 frame leg, 2 foot pole sections, longer track support pieces, a 2 foot black tabletop piece and 9.5-foot leaders along with replacement Velcro.

PLEASE NOTE – the 8' Lite Frame should not be extended beyond 10ft.

COMPATIBLE | 8

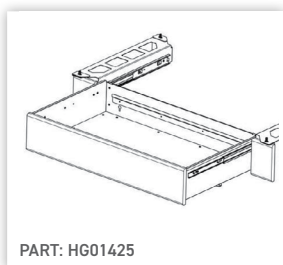

## ProFrame Drawer 4'

Designed to blend right in with easy-open design with smooth glides and zinc-plated hardware that resists corrosion - Rated at 100 lbs. Choose front or back access installation and install up to 3 drawers per 12-foot frame. Note: Drawers clear the batting storage pole, but not the roll of batting. If you store batting on your frame, we recommend installing only one drawer.

COMPATIBLE | 10 12

\*Standard Accessory, comes with the machine or frame.

# Long Arm Frames and Accessories

---



## 2' ProFrame Section

The Quilt Maker ProFrame 2' section replaces the existing 4 foot section on a 12' ProFrame to create a 10 foot frame. Includes a 2 foot table section, 2 foot poles (5) and 9.5 foot leaders (3).

COMPATIBLE	12
------------	----

\*Standard Accessory, comes with the machine or frame.



# Long Arm Frames and Accessories

## QMP16 Long Arm and 5' Frame Specific Accessories - Limited Quantities or Special Order

### 5' ProFrame Upgrade Kit

The Janome Quilt Maker ProFrame 5' upgrade kit includes special brackets and poles which allow the quilt to be rolled and advanced to simplify quilting small quilts on your space-saving ProFrame 5'. Leaders are included with this kit.

PART: QF00011-JA

### 5' ProFrame Drawer

Beautifully designed to blend right in with easy-open design with smooth glides. Choose front or back access installation. Rated at 100 lbs with Zinc-plated hardware resists corrosion.

Compatible only with the 5' ProFrame

PART: HG01415

### 4.5' Leader Set

Ideal for 5 foot frames. Set of two leaders. Firmly woven, sturdy twill cotton fabric with loop Velcro for attaching to poles.

PART: QF09561

### QMP16 - Rear Handlebar and Display Kit

Rear handlebars functions mirror the front handlebars, making it easy to move from the front to the back with consistency. A bright interactive LCD screen displays user settings. Use pantographs for edge-to-edge quilting in conjunction with the included laser light.

PART: QM29405

### QMP16 - Ruler Base

Made from thick durable acrylic, the ruler base accessory extends from the base of the long arm to provide a firm stable surface when using rulers, guides and templates.

PART: HG00457

## Compatible QMP16 Long Arm Products

Pinpoint Needle Laser | PART: HG01005-JA

Channel Locks | PART: HG00198-2

Tool Tray | PART: HG00271

Horizontal Spool Pin | PART: HG00396

EZ-Wind Bobbins (8) | PART: HG00238

Bobbin Case | PART: QM10585

Hand Wheel Kit | PART: QF09324

10' ProFrame | PART: PROFRAME10



\*Standard Accessory, comes with the machine or frame.



— Long Arm Reference Guide —



# JANOME

UPDATED JANUARY 2023

-----  
WWW.JANOME.CA  
-----