

Card Trick

Entered size (W x H) : 8 x 8 inch

Seam allowance : 1/4 inch

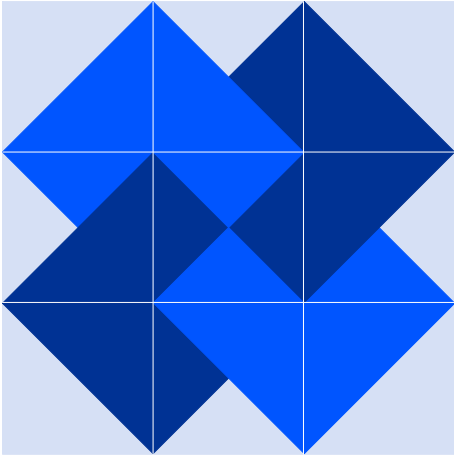

Completed pattern size (W x H) : 7 7/8 x 7 7/8 inch

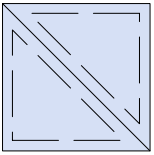

A1 x 2
W: 3 1/2 inch
H: 3 1/2 inch



A2 x 2
W: 3 1/2 inch
H: 3 1/2 inch

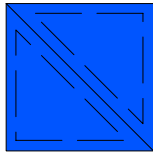

A3 x 2
W: 3 1/2 inch
H: 3 1/2 inch

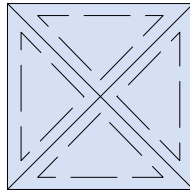

B1 x 1
W: 3 7/8 inch
H: 3 7/8 inch

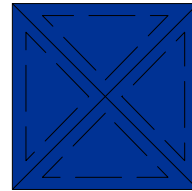

B2 x 1
W: 3 7/8 inch
H: 3 7/8 inch

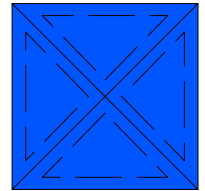

B3 x 1
W: 3 7/8 inch
H: 3 7/8 inch

Actual piece size (Seam allowance : 1/4 inch)

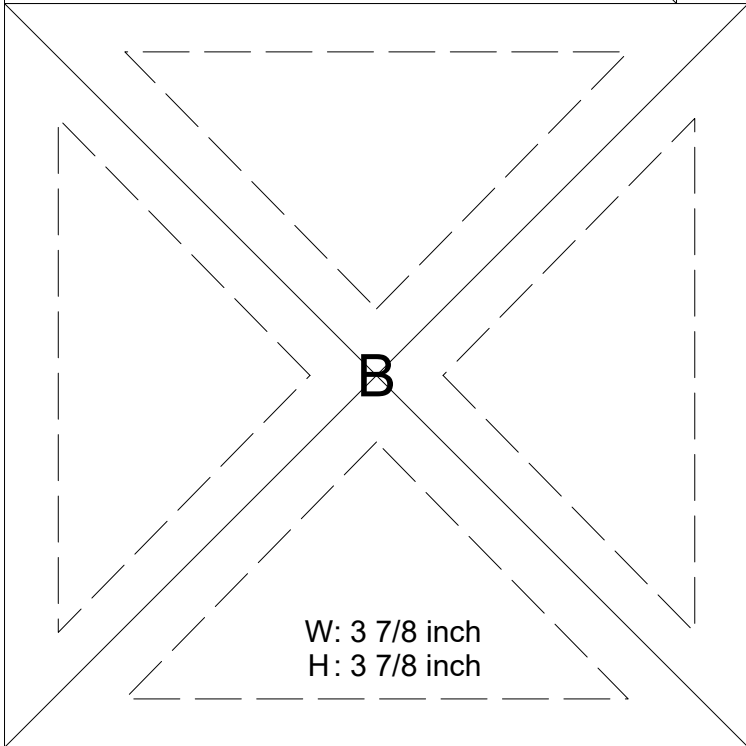
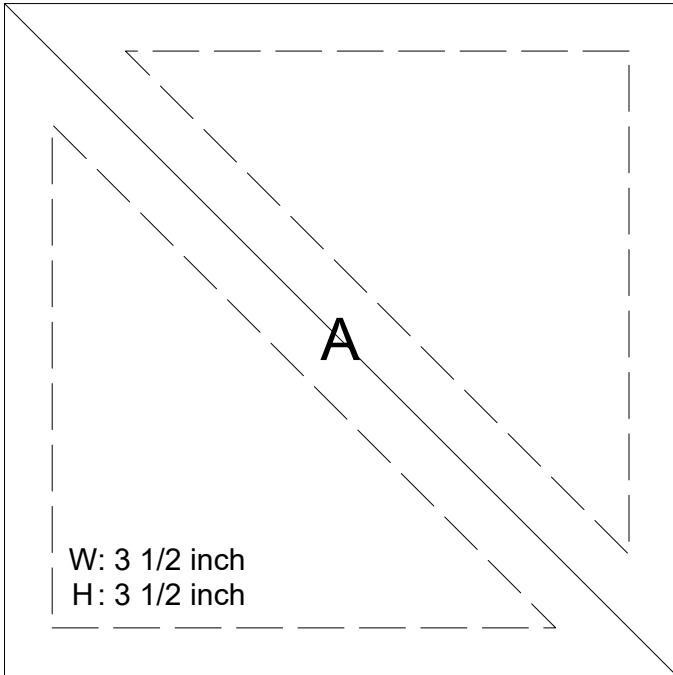

Card Trick

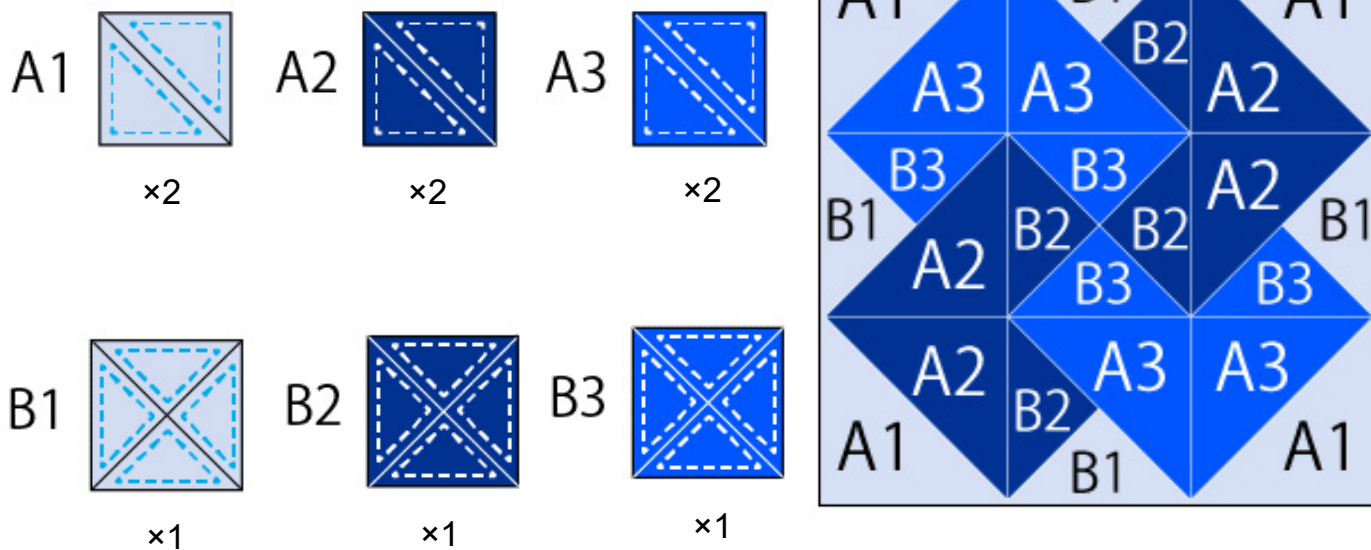

1. Cutting

Half square triangles (A)

Prepare three pieces of fabric (A1, A2 and A3) in different colors.

Cut two squares with "a" length from A1, A2 and A3 respectively.

The value of "a" is noted in Piece A1, A2 and A3 Width/Height in the left side of screen.

Cut A1, A2 and A3 squares on diagonal to make four triangles respectively.

*The number of pieces varies depending on the number of required half square triangle pieces.

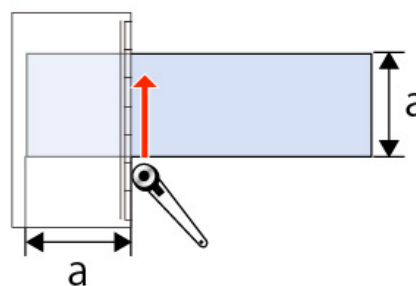
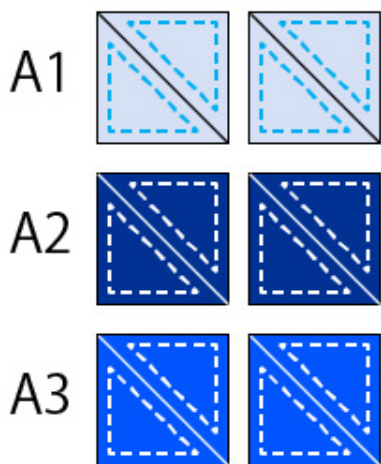

Quarter square triangles (B)

Prepare three pieces of fabric (B1, B2 and B3) in different colors.

Cut one square with "b" length from B1, B2 and B3 respectively.

The value of "b" is noted in Piece B1, B2 and B3 Width/Height in the left side of screen.

Cut B1, B2 and B3 squares on diagonal in both directions to make four triangles respectively.

*The number of pieces varies depending on the number of required quarter square triangle pieces.

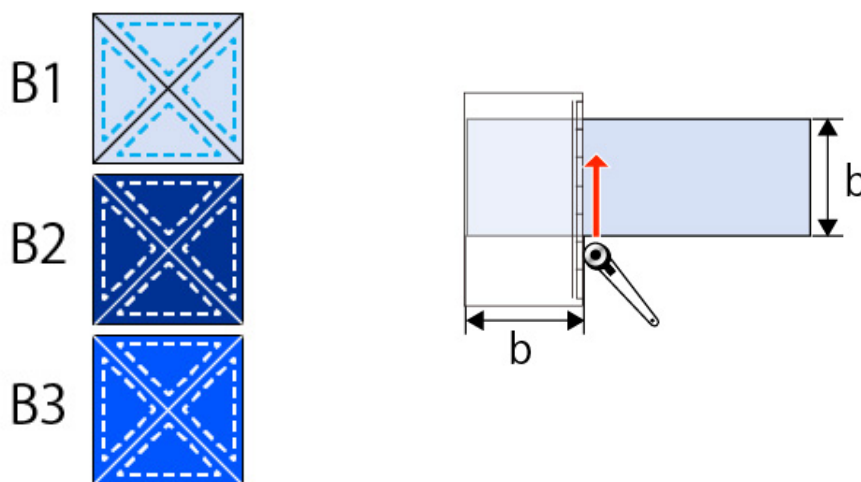

NOTE:
 Refer to [How to select the stitch's "Stitch Pattern", "Foot" and "How to use the foot"](#).
 [
 If a security warning message is appeared, click "Allow".

2. Block Assembly

- ① Place A1 and A2 or A1 and A3 right sides facing. Place triangles under the presser foot, lining up the long sides of the pieces with the right hand edge of the foot to sew. Press seams towards A1. Make two units respectively.

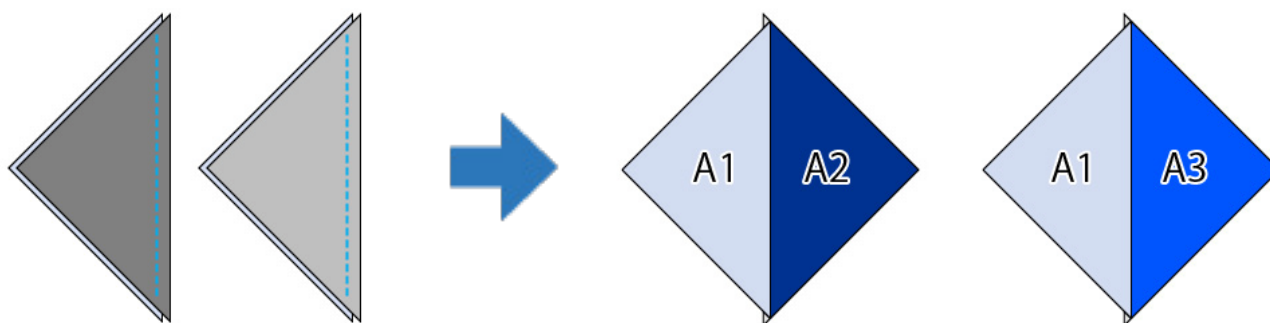

- Place B1 and B2 or B1 and B3 right sides facing. Place triangles under the presser foot, lining up the short sides of the pieces with the right hand edge of the foot to sew. Press seams towards B2 or B3. Make two units respectively.



- Place B2 and B3 right sides facing. Place triangles under the presser foot, lining up the short sides of the pieces with the right hand edge of the foot to sew.

Press seams towards B3.

Make two units.



- Sew pieced quarter square triangles (units made in step②) and half square triangle (A2 or A3) together.

B1-B2 to A3, matching each point (red circle part) and long sides together.

B1-B3 to A2, matching each point (red circle part) and long sides together.

Press seams towards half square triangle (A3 or A2).

Make two units respectively.

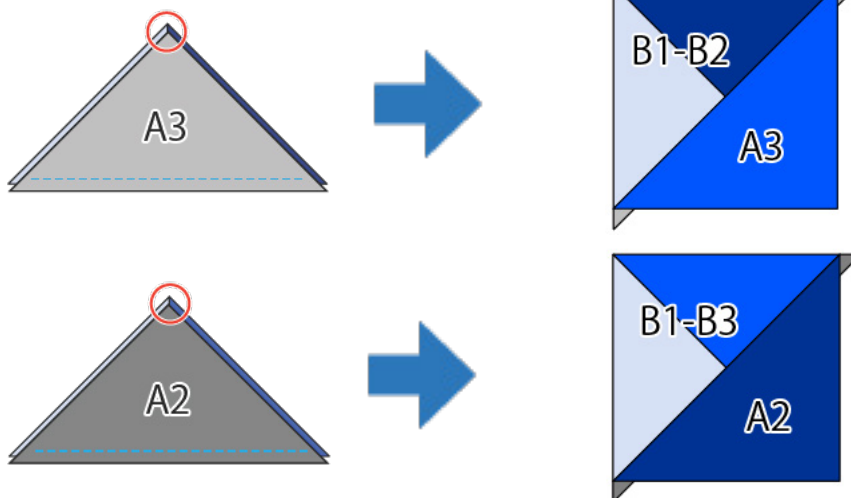

- Sew pieced quarter square triangles (units made in step③) right sides and opposite fabrics facing.

Press seams in one direction.

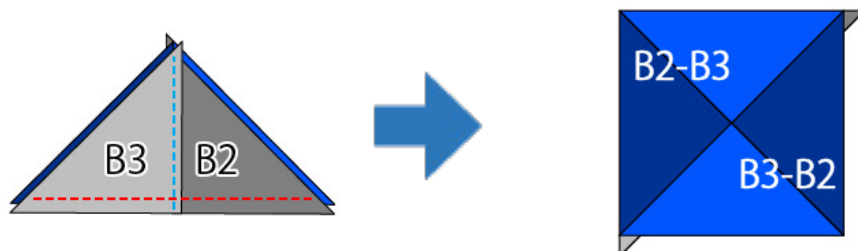

3. Quilt Assembly

① Lay out the units as shown in the Card Trick Block Assembly Diagram.

Card Trick Block Assembly Diagram

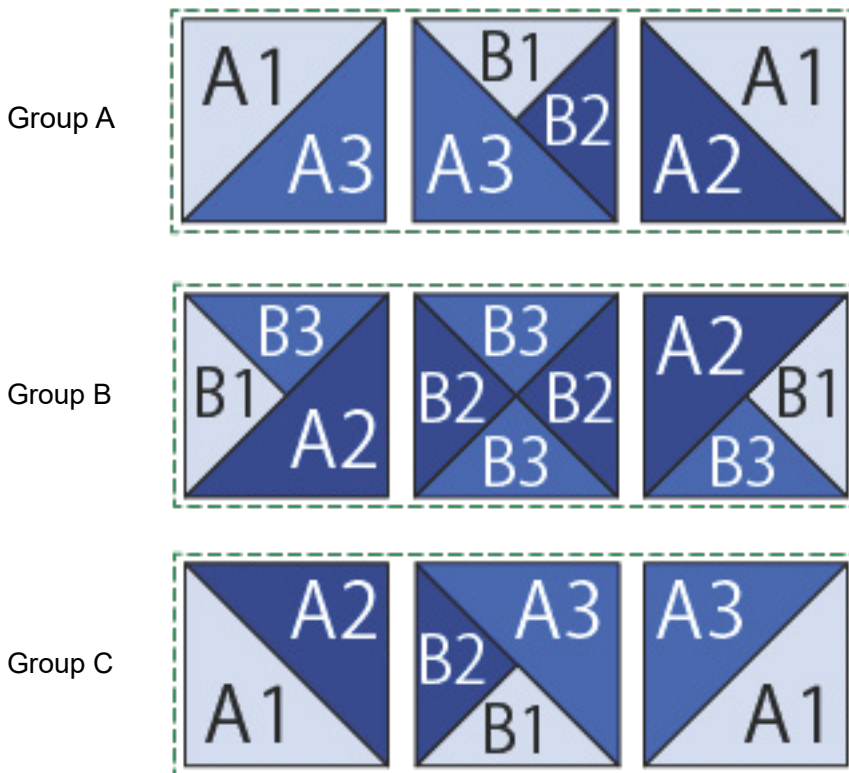

- Sew units together into groups.

Place next to each unit right sides facing. Place the units under the presser foot, lining up the edge of the fabric with the right hand edge of the foot to sew.

Group A: Press seams towards A1-A3 , B1-B2-A3.

e.g.: Group A

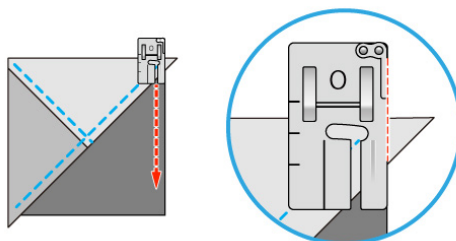
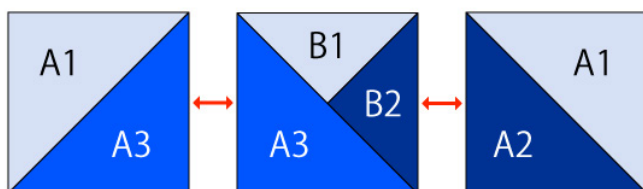

Make Group B and Group C as the same.

Group B: Press seams towards B2-B3 , B1-B3-A2.

Group C: Press seams towards A1-A2 , B1-B2-A3.

NOTE:

Cut off dog ears.

- Sew Group A, Group B and Group C together to complete one Card Trick block.

NOTE:

Use marking pins to match the pieces together.

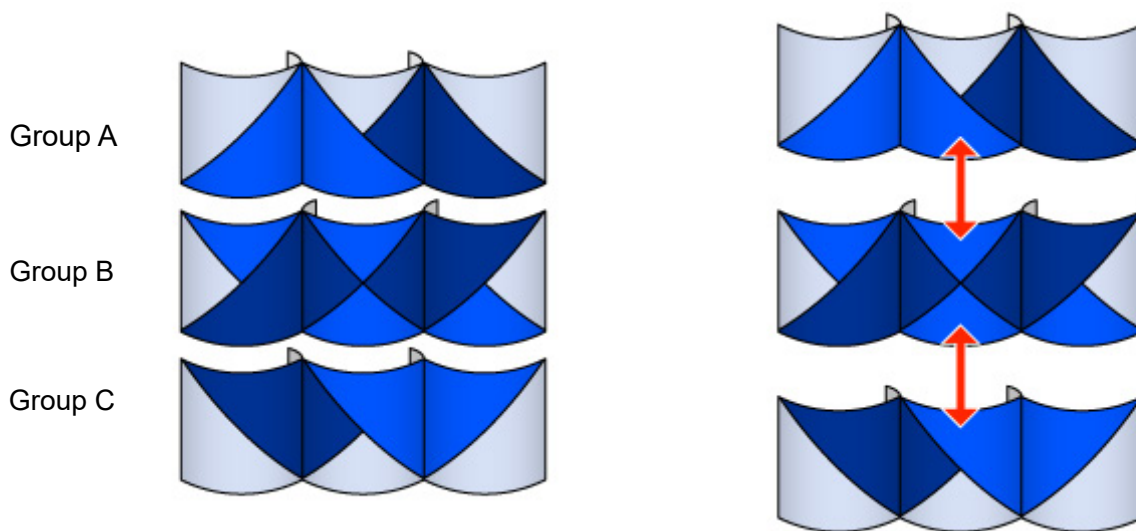

Ⓢ Press seams in one direction.

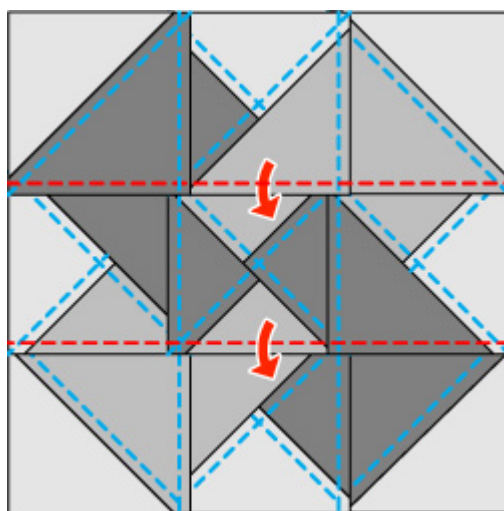

© Arrange blocks as desired.

Finish

